

CertainTeed

2015 Siding Collection

Vinyl & Polymer Siding



1665 - 2015

CertainTeed
SAINT-GOBAIN

Welcome to the CertainTeed Siding Collection

For more than 100 years, homeowners and building professionals have trusted CertainTeed for the highest quality building products, and continually setting the standards for exciting innovations in style and performance.

Today, that spirit of innovation comes to life in the CertainTeed Siding Collection – an exceptional selection of siding products offering the industry’s broadest choice of options in materials, styles, colors and performance options.



Shakes & Shingles

Cedar Impressions® Shingles	6
Cedar Impressions® Shakes	12
Northwoods®	16

On Cover:

Siding: Cedar Impressions D7" Straight Edge Perfection Shingles in cypress.

Trim: Vinyl Carpentry® & Restoration Millwork®.

Roof: Landmark® TL in shenandoah.



Insulated

CedarBoards™/ XL.....	20
-----------------------	----



Horizontal

Monogram®/ XL	26
Restoration Classic™	30
Carolina Beaded™	34
MainStreet™	36
Wolverine American Legend™	42
Encore™	44



Professionals agree, CertainTeed still leads the Vinyl and Polymer Siding industry

For the 18th year in a row, builders and contractors named CertainTeed Vinyl Siding Number One in the categories: Brand Familiarity; Brands Used in the Past Two Years; Brands Used Most and Highest Quality Brand in the 2014 Builder magazine Brand Use Study. For the 9th year straight CertainTeed CedarBoards™ has been ranked Number One in all categories surveyed for Insulated Siding. Consistently, CertainTeed has emerged the industry leader.



Vinyl Carpentry®.....54



Restoration Millwork®.....56



Finishing Touches.....58



UnderShield®.....60



CertaWrap™.....62



EverNew® Railing.....64



Vertical

Board & Batten46



Soffit / Vertical

Chamfer Board™ Vertical Siding48

Triple 3-1/3".....50

Perimeter™50

Beaded.....50

Ironmax™52

Universal52

Value.....52

Icon Guide

Below you will find an explanation of each icon used for easy reference to identify and compare the many product features, benefits and specifications of the siding products offered by CertainTeed.



Panel Thickness:

Defines the average thickness or gauge of a siding panel which is an important element of siding quality. Thicker panels look straighter on the wall, are more durable, and hold up against impacts and high winds. CertainTeed siding products are regularly audited by Architectural Testing, Inc. to ensure they meet or exceed ASTM standards for vinyl siding.



Profiles:

Lists the number of different profiles available within each product line. A profile is the contour or outline of a siding panel as viewed from the side or end. Product profiles, such as clapboard and dutchlap, are designed to mimic the different architectural styles of wood cladding products.



Colors:

Shows the number of different colors available within each product line. The CertainTeed Siding Collection features solid colors that replicate the look of freshly painted cedar and variegated blends which provide the appearance of semi-transparent stained finish.



Wind Load:

This is the rating for the maximum wind pressure that a siding product can withstand. All CertainTeed Siding products are rigorously tested by Architectural Testing Inc. to meet or exceed ASTM standards for resistance to negative wind load pressures.



Nail Hem Design:

Identifies the type of nail hem design on a siding product. Rollovers and / or reinforcing ribs are used to stiffen the nail hem of a siding panel, giving it a straighter appearance on the wall while contributing to the wind load resistance of the product.



Panel Projection:

Identifies the full depth of a siding panel as measured from the back of the panel to the tip of the front of the panel. Deeper panel projections add rigidity to siding products while providing wider shadow lines that enhance aesthetics. This measurement is also used for proper sizing of accessories necessary to install the siding.



Texture:

Indicates available textures within each product line. Whether you are seeking the smooth appearance of milled cedar, or one of the many TrueTexture™ woodgrains molded from real cedar boards, CertainTeed offers a wide array of architecturally authentic product textures to choose from.



Lock:

Designates the panel lock design of the product. CertainTeed Siding Products feature proprietary locking designs created to optimize the alignment and installation for each specific product. The special features of CertiLock™ and DuraLock® ensure that every siding panel goes on the wall straight and secure.

Colors shown throughout this brochure are as accurate as printing methods will permit. Please see product samples before making final selection.

**Warranty:**

All CertainTeed Siding Collection products are covered by a Lifetime Limited Warranty, backed by an industry leader and trusted brand for over 110 years.

**Fastener Indicator:**

CertainTeed is the only siding engineered to include an integral fastener placement guide on each panel. The Patented STUDfinder™ Installation System and Cedar Impressions® fastener indicators are designed to help ensure a safe, precise installation for maximum siding performance.

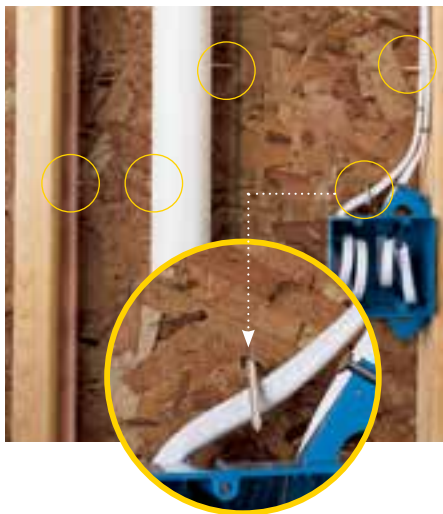

Precise fastener installation using the STUDfinder Installation System contributes to wind load performance, and helps avoid nailing into anything located between the studs, like plumbing or wiring, that could create a number of dangers.

**Flame Spread Rating:**

Indicates products that are Class A Flame Spread Classified, meaning that the material is highly resistant to fire and does not spread flames quickly and/or is self-extinguishing.

**Fade Protection:**

CertainTeed offers an industry-leading spectrum of colors including unique, darker shades and semi-transparent stained blends for virtually unlimited design possibilities. Utilizing the unique PermaColor™ System – a blend of our own Certavin™ resin, superior micro-ingredients and state-of-the-art pigment chemistry – CertainTeed guarantees Lifetime Fade Protection on our vinyl siding.

**Extended Lengths:**

Indicates products that are available in extended lengths, including 16', 20' and 25'. Longer length siding significantly reduces the number of seams when panels overlap horizontally, increasing the overall aesthetics of the wall.

**Low Maintenance:**

Vinyl siding, insulated siding, and polymer siding products are some of the lowest maintenance exterior cladding products available. Unlike other cladding products that require regular repainting, recaulking, tuckpointing, and sealing to maintain their aesthetics, CertainTeed siding products can be kept beautiful using a soft bristle brush and a bucket of soapy water.

Life Cycle Leadership

CertainTeed believes a product's environmental performance should not be a mystery. CertainTeed is the first siding producer to submit their Life Cycle Analysis data to be reviewed, approved, and implemented by the National Institute of Standards and Technology (NIST).



The Building for Economic and Environmental Sustainability (BEES) on-line product evaluation program allows remodelers, builders, architects, and homeowners to evaluate any building product's environmental performance. For more information, go to www.certainteed.com/LCA.



This NGBS Research Labs Green Approved mark is your assurance that a product is eligible for points toward National Green Building Certification.

Visit www.GreenApprovedProducts.com for more details.

Cedar Impressions®

Perfection Shingles



.100"
Perfection &
Half-Round



4



30



up to
210mph



Reinforced
Nail Slots



3/4"
Panel
Projection



TrueTexture



Molded
Perimeter
Lock



Lifetime
Limited
Warranty



Fastener
Indicators



Low
Maintenance



Siding: Cedar Impressions Double 7" Straight Edge Perfection Shingles in seagrass.
Trim: Vinyl Carpentry® & Restoration Millwork®.
Roof: Highland Slate in fieldstone.



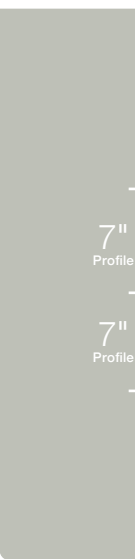
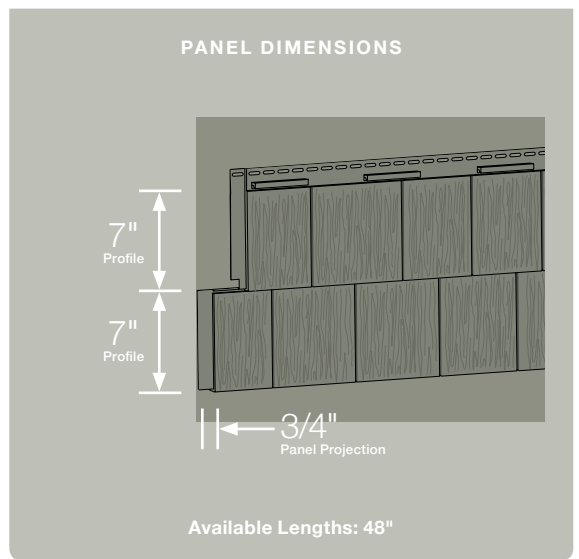
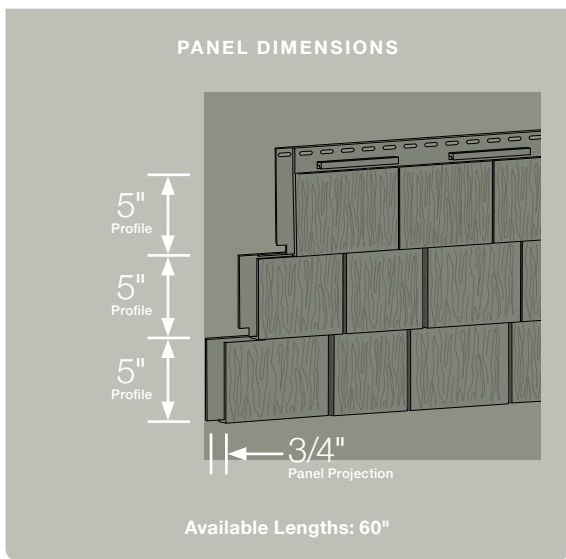



Double 7"
Staggered
Perfection Shingles

pacific blue



Double 6-1/4"
Half-Round Shingles

ivy green

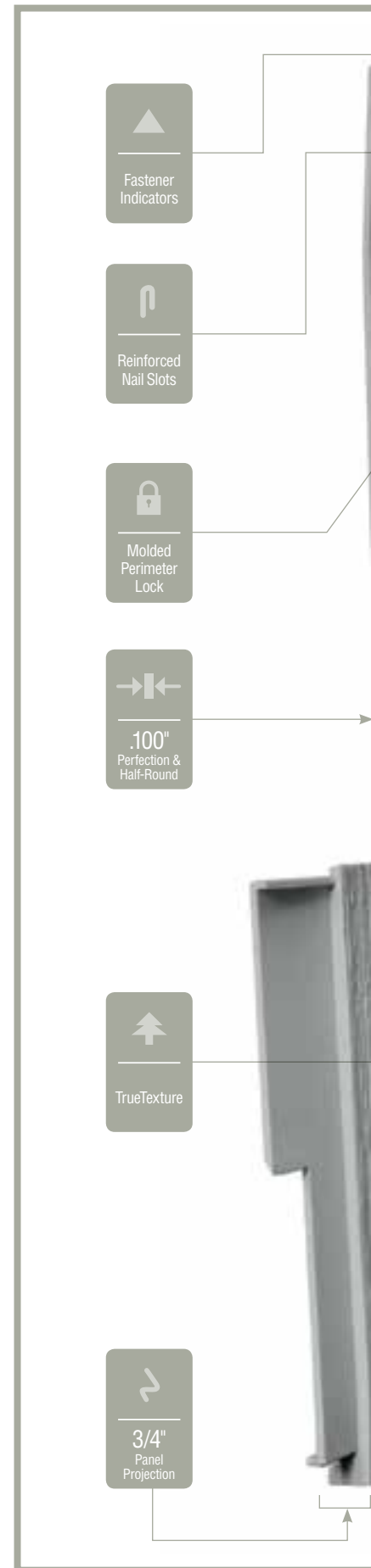
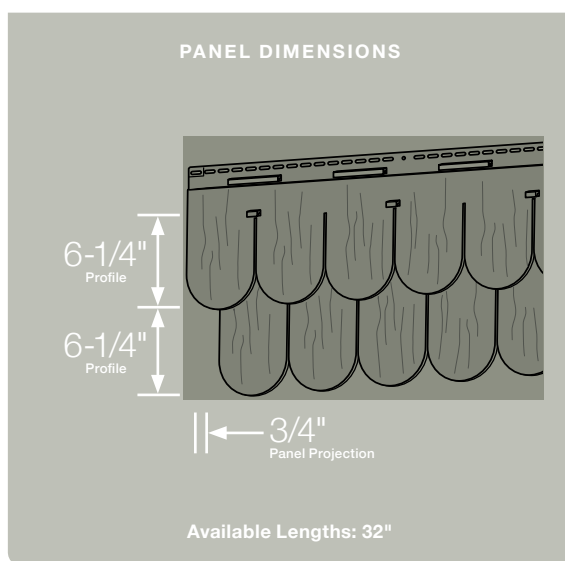
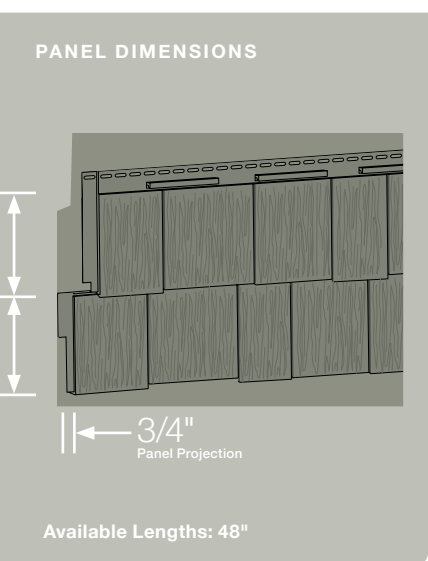



The patented **PanelThermometer™** and temperature lines are designed to ensure precise installation.

	T5 Straight Edge Perfection Shingles	D7 Straight Edge Perfection Shingles	D7 Staggered Perfection Shingles	D6 ^{1/4} Half Round Shingles	
Autumn Red		●	●	●	
Terra Cotta		●	●	●	
Mountain Cedar	●	●	●	●	
Sable Brown		●	●	●	
Hearthstone	●	●	●	●	
Suede	●	●	●	●	
Spruce		●	●	●	
Forest		●	●	●	
Ivy Green		●	●	●	
Pacific Blue		●	●	●	
Flagstone		●	●	●	
Charcoal Gray		●	●	●	
Granite Gray	●	●	●	●	
Sterling Gray	●	●	●	●	
Bermuda Blue		●	●	●	
Seagrass	●	●	●	●	
Cypress	●	●	●	●	
Green Tea		●	●	●	
Herringbone	●	●	●	●	
Sandstone Beige	●	●	●	●	
Desert Tan	●	●	●	●	
Natural Clay	●	●	●	●	
Savannah Wicker	●	●	●	●	
Light Maple	●	●	●	●	
Buckskin	●	●	●	●	
Sandpiper	●	●	●	●	
Heritage Cream	●	●	●	●	
Autumn Yellow	●	●	●	●	
Snow	●	●	●	●	
Colonial White	●	●	●	●	

Finishing Touches



Inside and Outside 45°
Mitered Bay Window
Cornerpost

Inside Cornerpost
for Double 7"
Perfection Shingles

D7" Staggered, T5" and D7"
Perfection Outside Cornerposts



Siding: Cedar Impressions Double 7" Straight Edge Perfection Shingles (1st floor) and Double 7" Staggered Perfection Shingles (2nd floor) in mountain cedar.

Accents: Half-Round Shingles in spruce and suede.

Trim: Vinyl Carpentry® & Restoration Millwork®.

Cedar Impressions®

Rough-Split Shakes



.125"
Rough-Split



2



28



up to
160mph



Reinforced
Nail Slots



1"
Panel
Projection



TrueTexture



Molded
Perimeter
Lock



Lifetime
Limited
Warranty



Fastener
Indicators



Low
Maintenance



Siding: Cedar Impressions Double 9" Staggered Rough-Split Shakes in hearthstone.
Trim: Vinyl Carpentry® & Restoration Millwork®.



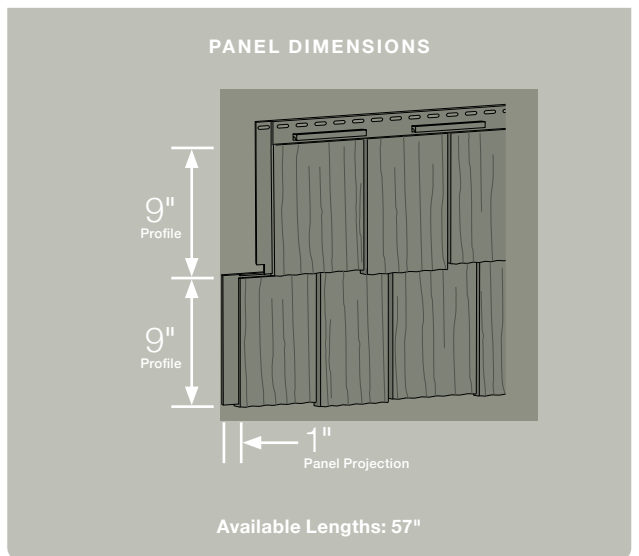
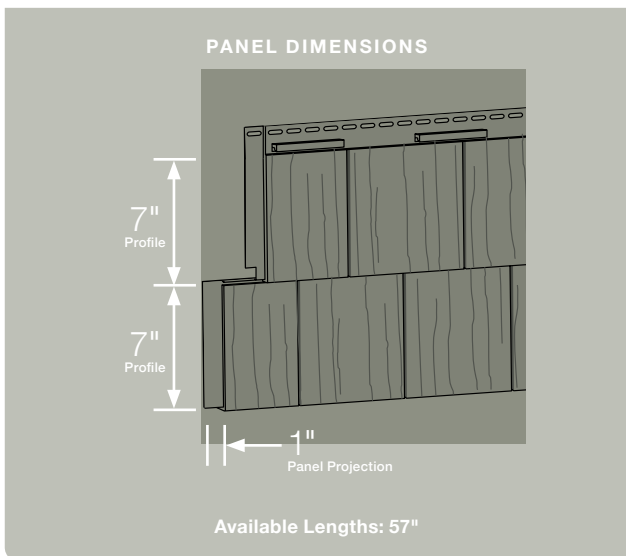

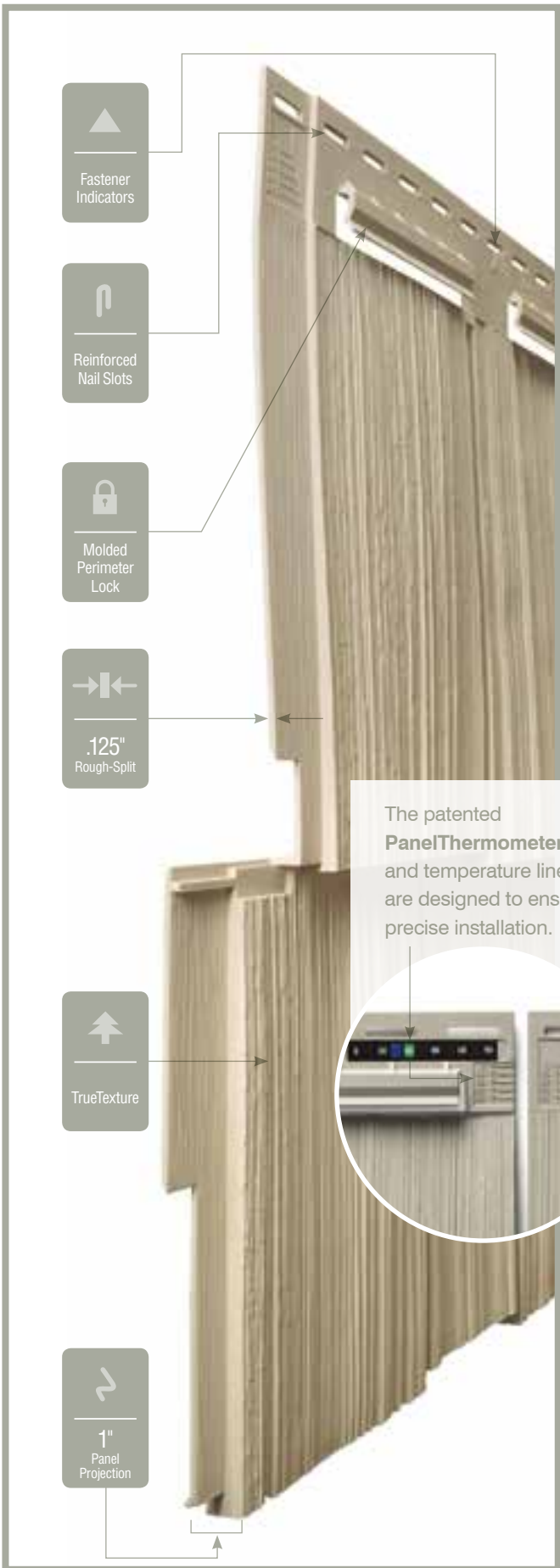

The patented **PanelThermometer™** and temperature lines are designed to ensure precise installation.

	D7 Straight Edge Rough-Split Shakes	D9 Staggered Rough-Split Shakes	
Autumn Red	●	●	
Terra Cotta	●	●	
Mountain Cedar	●	●	
Sable Brown	●	●	
Hearthstone	●	●	
Suede	●	●	
Spruce	●	●	
Forest	●	●	
Ivy Green	●	●	
Pacific Blue	●	●	
Flagstone	●	●	
Charcoal Gray	●	●	
Granite Gray	●	●	
Sterling Gray	●	●	
Seagrass	●	●	
Cypress	●	●	
Herringbone	●	●	
Sandstone Beige	●	●	
Desert Tan	●	●	
Natural Clay	●	●	
Savannah Wicker	●	●	
Light Maple	●	●	
Buckskin	●	●	
Sandpiper	●	●	
Heritage Cream	●	●	
Autumn Yellow	●	●	
Snow	●	●	
Colonial White	●	●	











Finishing Touches



D7" Rough-Split Mitered Outside Cornerpost

D9" Rough-Split Mitered Outside Cornerpost

Northwoods®

									
.050"	2	17	up to 180mph	Standard Nail Hem	1" Panel Projection	TrueTexture	Lifetime Limited Warranty	Class A Flame Spread	Low Maintenance



Siding: Northwoods Single 7" Straight Edge Rough-Split Shakes in sable brown.
Trim: Vinyl Carpentry® & Restoration Millwork®.



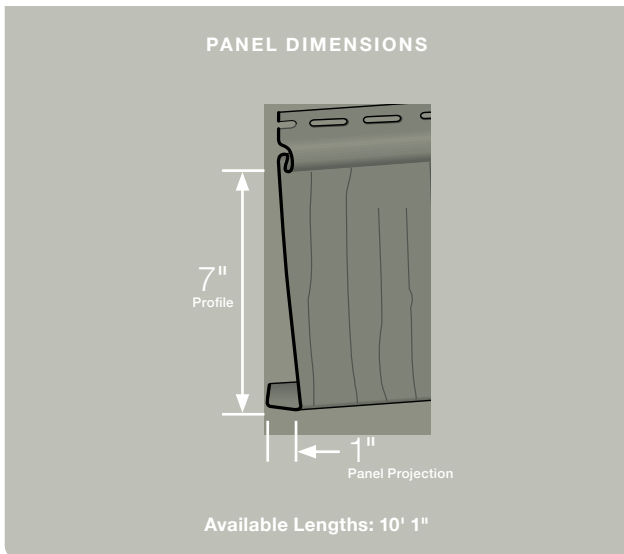
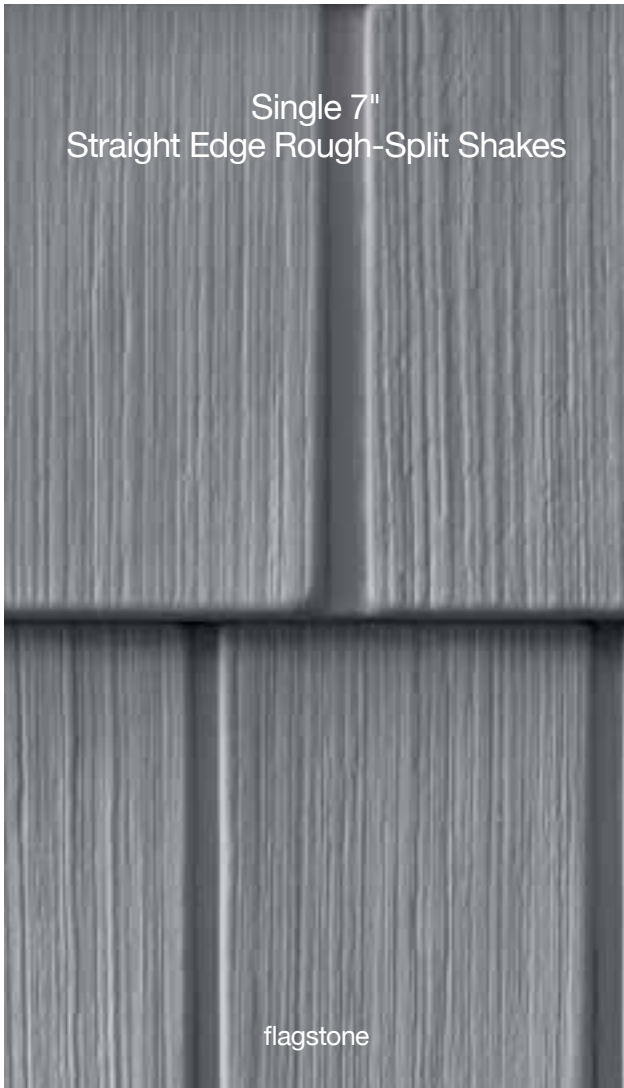

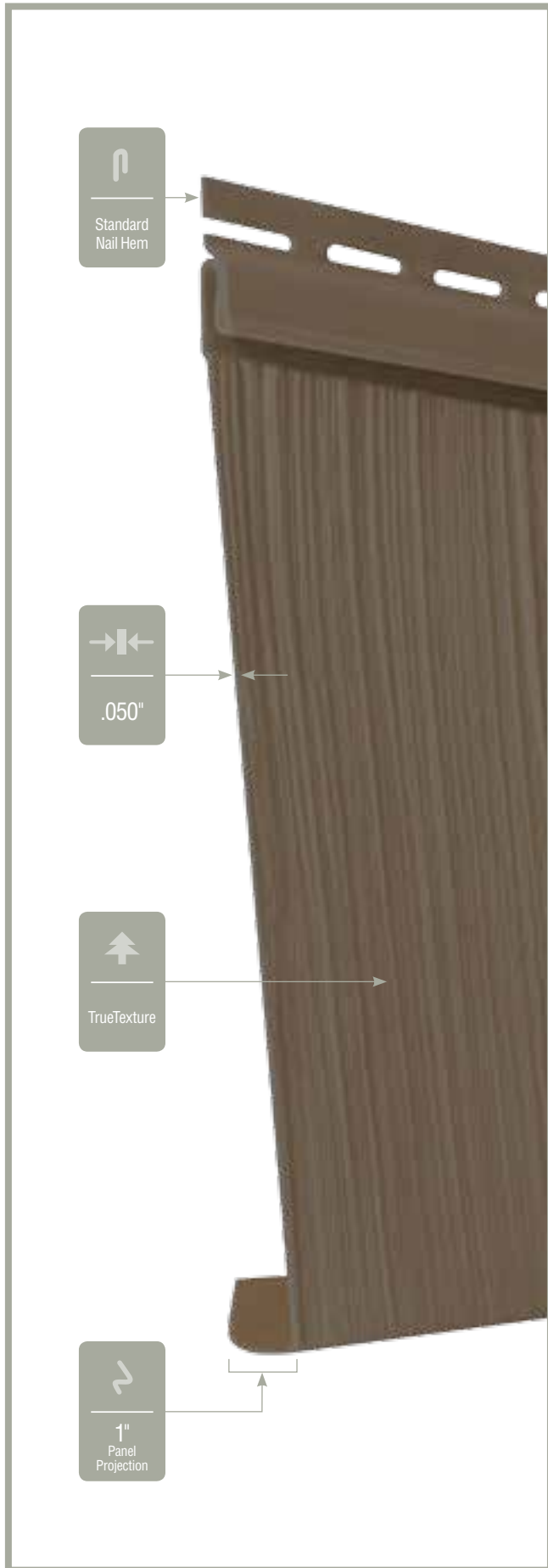

	S7 Straight Edge Rough-Split Shakes	S9 Staggered Rough-Split Shakes	
Autumn Red	●	●	
Sable Brown	●	●	
Ivy Green	●	●	
Pacific Blue	●	●	
Flagstone	●	●	
Granite Gray	●	●	
Sterling Gray	●	●	
Cypress	●	●	
Sandstone Beige	●	●	
Desert Tan	●	●	
Natural Clay	●	●	
Savannah Wicker	●	●	
Light Maple	●	●	
Buckskin	●	●	
Heritage Cream	●	●	
Autumn Yellow	●	●	
Colonial White	●	●	



Siding: Northwoods Single 7" Straight Edge Rough-Split Shakes in cypress with Monogram Double 4" Clapboard in natural clay.

Trim: Vinyl Carpentry® & Restoration Millwork®.

CedarBoards™

Chosen by Builders and Remodelers as the
#1 Insulated Siding
in Brand Awareness,
Performance and Use.



.044"
D6, S7, D4,
D4-1/2 DL



.052"
S12



5



23



Full
Rollover
Nail Hem



1-1/4"
Panel Projection
(complete assembly)



TrueTexture



DuraLock



Lifetime
Limited
Warranty



STUDfinder



Class A
Flame Spread



PermaColor
Fade
Protection



Longer
Lengths
Available



Low
Maintenance



Siding: CedarBoards Double 6" XL Clapboard in natural clay.
Trim: Vinyl Carpentry® & Restoration Millwork®.





Double 6"
Rough Cedar Clapboard



flagstone

Single 7"
Rough Cedar Clapboard



sable brown

Do
Rough Ce



ste

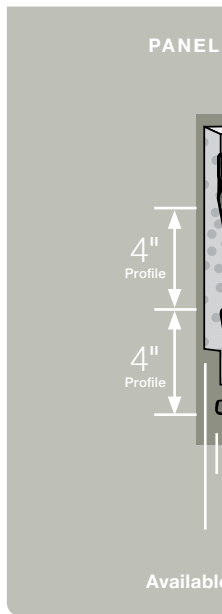
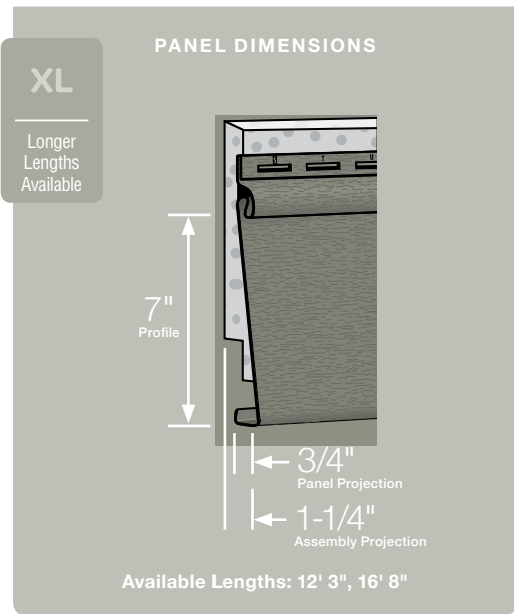
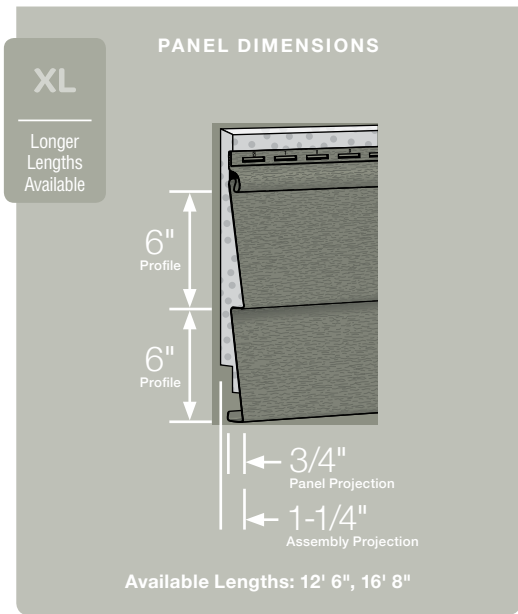



Double 4"
Rough Cedar Clapboard

whispering gray

DIMENSIONS

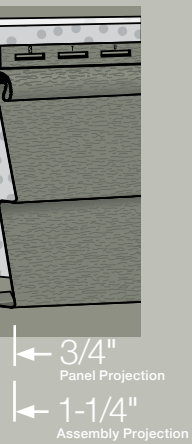

Available Lengths: 12' 6"



Double 4-1/2"
Rough Cedar Dutchlap

suede

PANEL DIMENSIONS

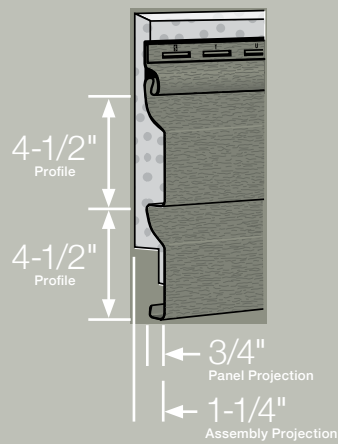

Available Lengths: 12' 1"



Single 12"
Rough Cedar
Board & Batten

autumn red

PANEL DIMENSIONS

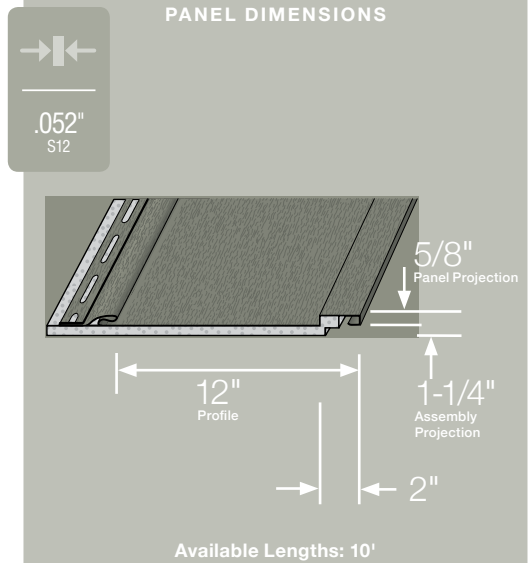

Available Lengths: 10'

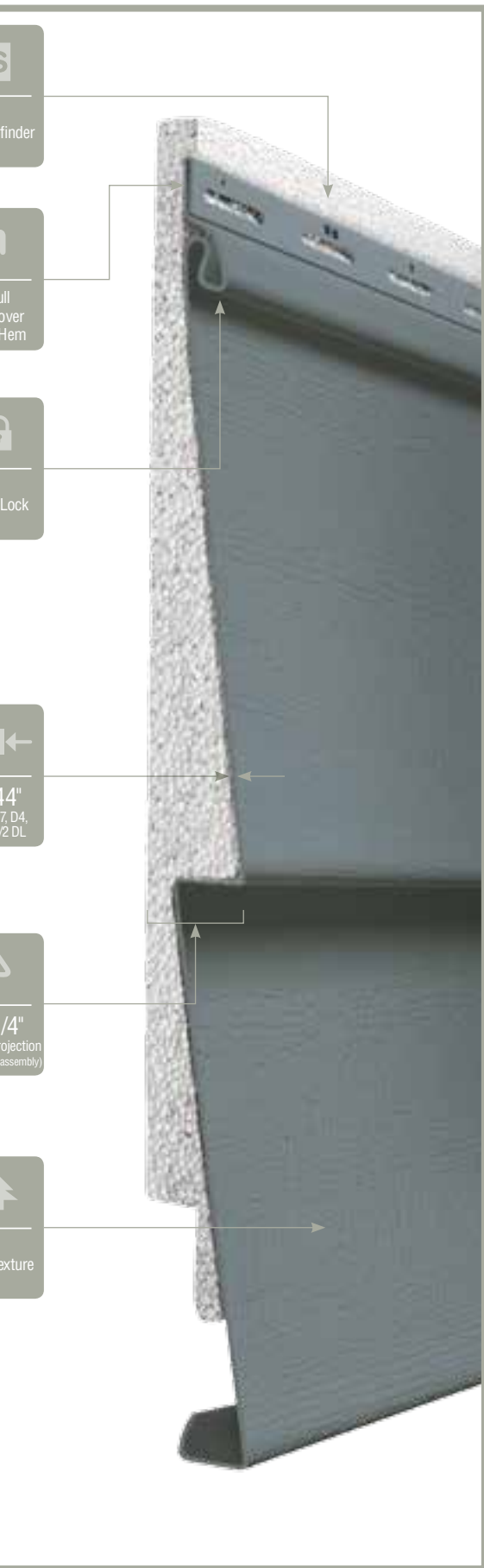

	D6 Clapboard	S7 Clapboard	D4 Clapboard	D4 ^{1/2} Dutchlap	S12 Clapboard	XL D6 Clapboard	XL S7 Clapboard
Frontier Blend**	●	●					
Timber Blend**	●	●					
Autumn Red*	●	●			●	●	●
Sable Brown*	●	●				●	●
Suede	●	●	●	●			
Spruce*	●	●				●	●
Pacific Blue*	●	●				●	●
Flagstone*	●	●				●	●
Charcoal Gray*	●	●				●	●
Granite Gray	●	●	●	●	●	●	●
Sterling Gray	●	●	●	●	●	●	●
Oxford Blue	●	●	●	●	●	●	●
Cypress	●	●	●	●	●	●	●
Sandstone Beige	●	●	●	●	●	●	●
Desert Tan	●	●	●	●	●	●	●
Natural Clay	●	●	●	●	●	●	●
Savannah Wicker	●	●	●	●	●	●	●
Light Maple	●	●	●	●	●	●	●
Buckskin	●	●	●	●			
Sandpiper	●	●	●	●			
Heritage Cream	●	●	●	●	●	●	●
Snow	●	●	●	●	●	●	●
Colonial White	●	●	●	●	●	●	●

*Deluxe Colors
**Premium Colors

Finishing Touches















A full line of Vinyl Carpentry accessories specially designed for use with CedarBoards siding.





Siding: CedarBoards Double 6" Clapboard in buckskin.
Trim: Vinyl Carpentry® & Restoration Millwork®.

Monogram®

 .046"	 3	 41	 up to 220mph	 Full Rollover Nail Hem	 3/4" Panel Projection	 TrueTexture	 Certilock	 Lifetime Limited Warranty	 STUDfinder	 Class A Flame Spread	 PermaColor Fade Protection	 Longer Lengths Available	 Low Maintenance
---	--	---	--	---	--	--	--	--	--	--	---	---	---



Siding: Monogram Double 4" Clapboard in sandpiper.
Trim: Vinyl Carpentry® & Restoration Millwork®.





Double 4"
Rough Cedar Clapboard

flagstone



Double 5"
Rough Cedar Clapboard

savannah wicker



Double 5"
Rough Cedar Dutchlap

frontier blend

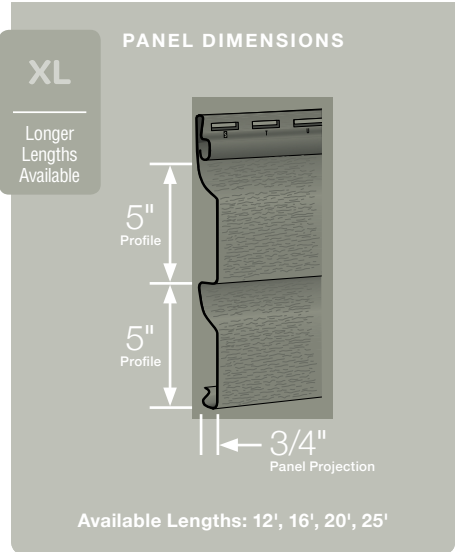
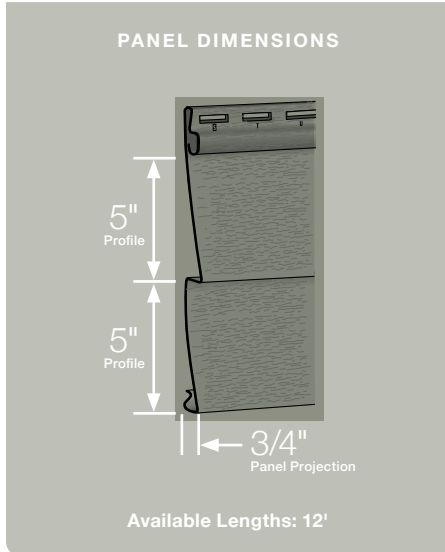
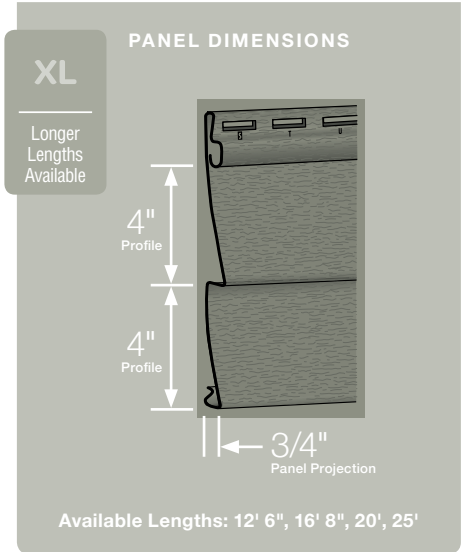

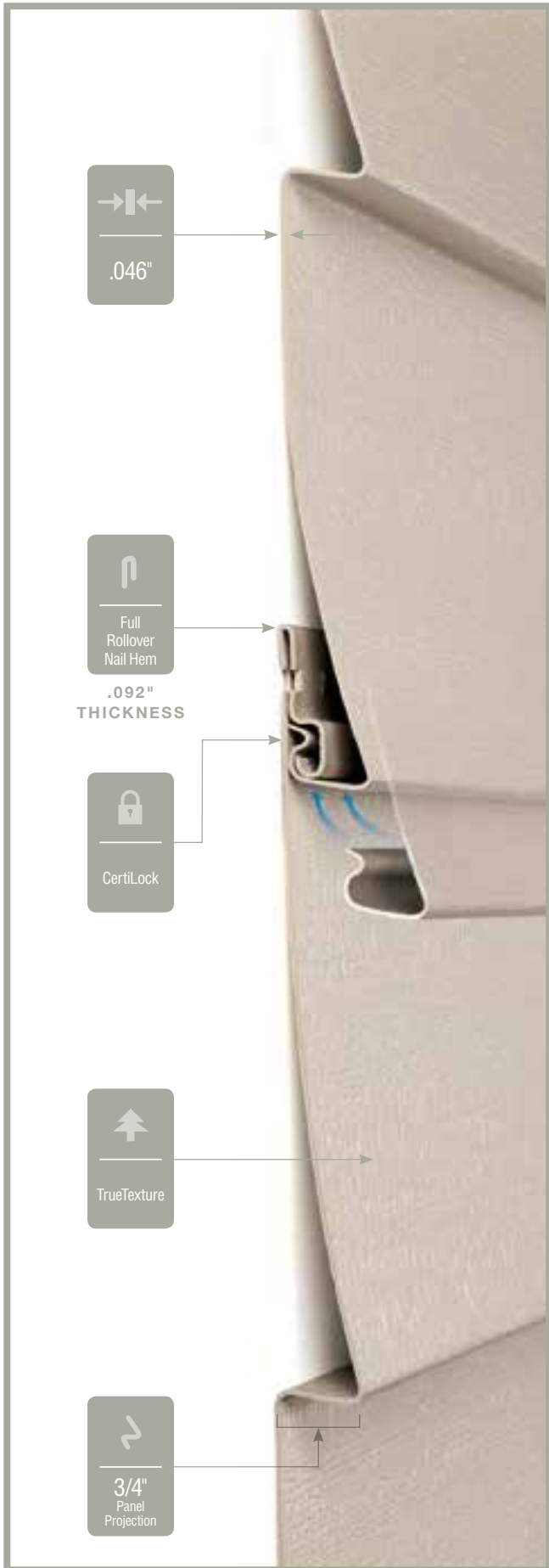

	D4 Clapboard	D5 Clapboard	D5 Dutchlap	XL Clapboard	XL Dutchlap
Arbor Blend**	●		●		
Arctic Blend**	●		●		
Weathered Blend**	●		●		
Frontier Blend**	●		●		
Timber Blend**	●		●		
Canyon Blend*	●		●		
Meadow Blend*	●		●		
Glacier Blend*	●		●		
Autumn Red*	●	●	●	●	●
Terra Cotta*	●				
Mountain Cedar*	●				
Sable Brown*	●	●	●	●	
Hearthstone*	●	●	●		
Suede	●	●	●		
Spruce*	●	●	●	●	
Forest*	●	●	●		
Ivy Green*	●				
Pacific Blue*	●	●	●	●	
Flagstone*	●	●	●		
Charcoal Gray*	●	●	●	●	
Granite Gray	●	●	●	●	●
Sterling Gray	●	●	●	●	●
Bermuda Blue	●				
Oxford Blue	●	●	●	●	●
Seagrass	●	●	●		
Cypress	●	●	●	●	●
Green Tea	●				
Linen	●	●	●		
Silver Ash	●	●	●	●	●
Herringbone	●	●	●		
Sandstone Beige	●	●	●	●	●
Desert Tan	●	●	●	●	●
Natural Clay	●	●	●	●	●
Savannah Wicker	●	●	●	●	●
Light Maple	●	●	●	●	●
Buckskin	●	●	●		
Sandpiper	●	●	●		
Heritage Cream	●	●	●	●	●
Autumn Yellow	●	●	●	●	●
Snow	●	●	●	●	●
Colonial White	●	●	●	●	●

*Deluxe Colors
**Premium Colors

Restoration Classic™

- |←
- ≡
- 🎨
- 🌀
- ⤴
- ↪
- 🔒
- ☰
- 📏
- 🔥
- ☀️
- 🏠
- .044"
- 5
- 28
- up to 210_{mph}
- Full Rollover Nail Hem
- 5/8" Panel Projection
- Select Cedar Woodgrain & Smooth
- DuraLock
- Lifetime Limited Warranty
- STUDfinder
- Class A Flame Spread
- PermaColor Fade Protection
- Low Maintenance



Siding: Restoration Classic Double 4" Clapboard in mountain cedar.
Trim: Vinyl Carpentry® & Restoration Millwork®.



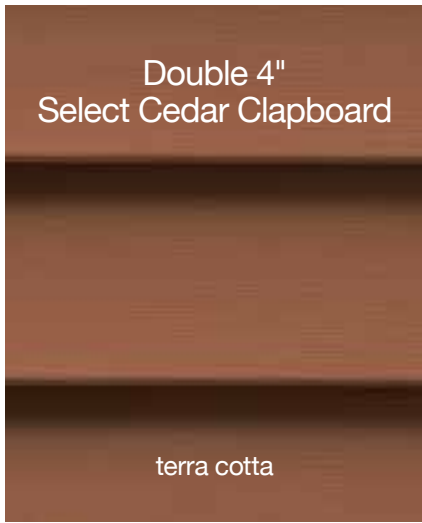

Double 4"
Select Cedar Clapboard

terra cotta

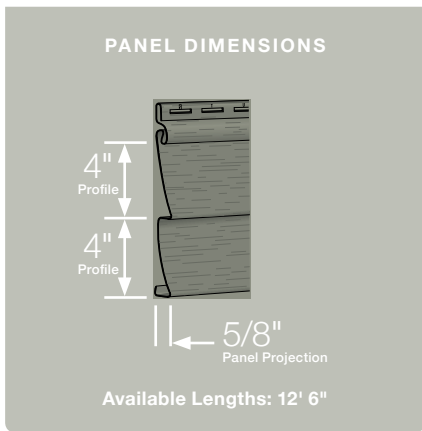

Double 4-1/2"
Select Cedar Dutchlap

charcoal gray

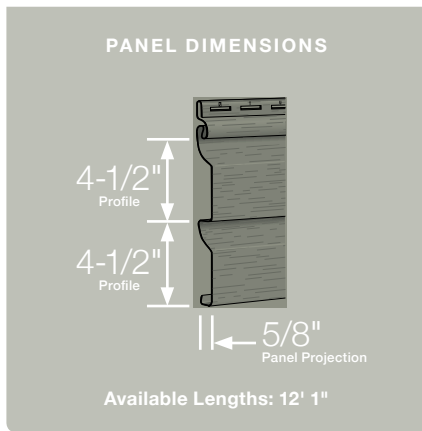

Double 5"
Select Cedar Clapboard

heritage cream

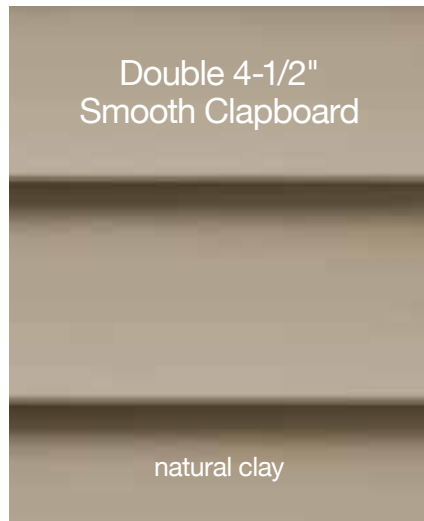
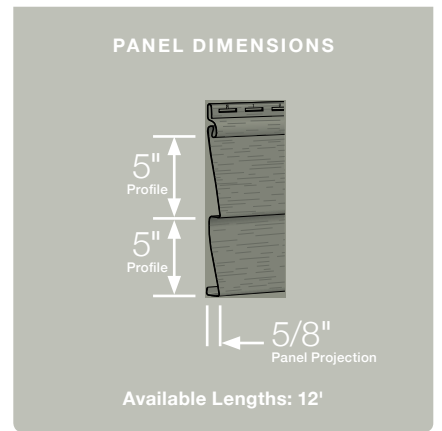

Double 4-1/2"
Smooth Clapboard

natural clay

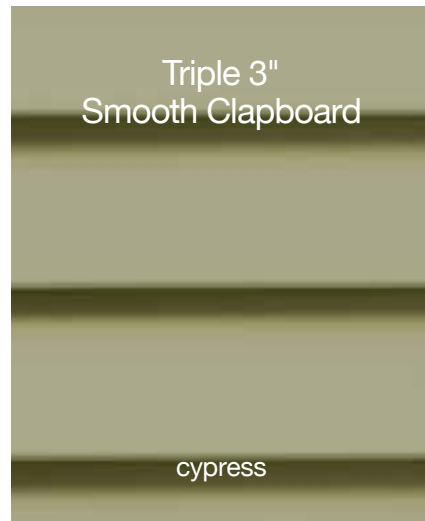
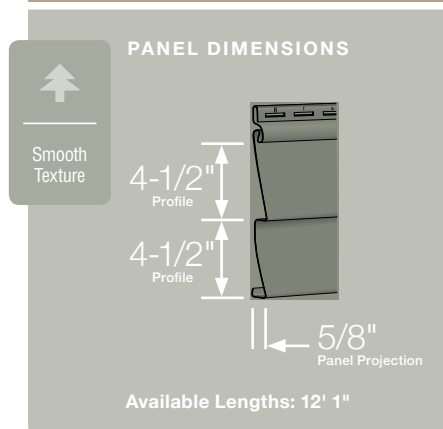

Triple 3"
Smooth Clapboard

cypress

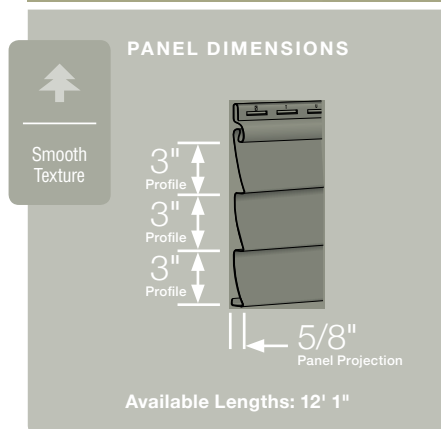

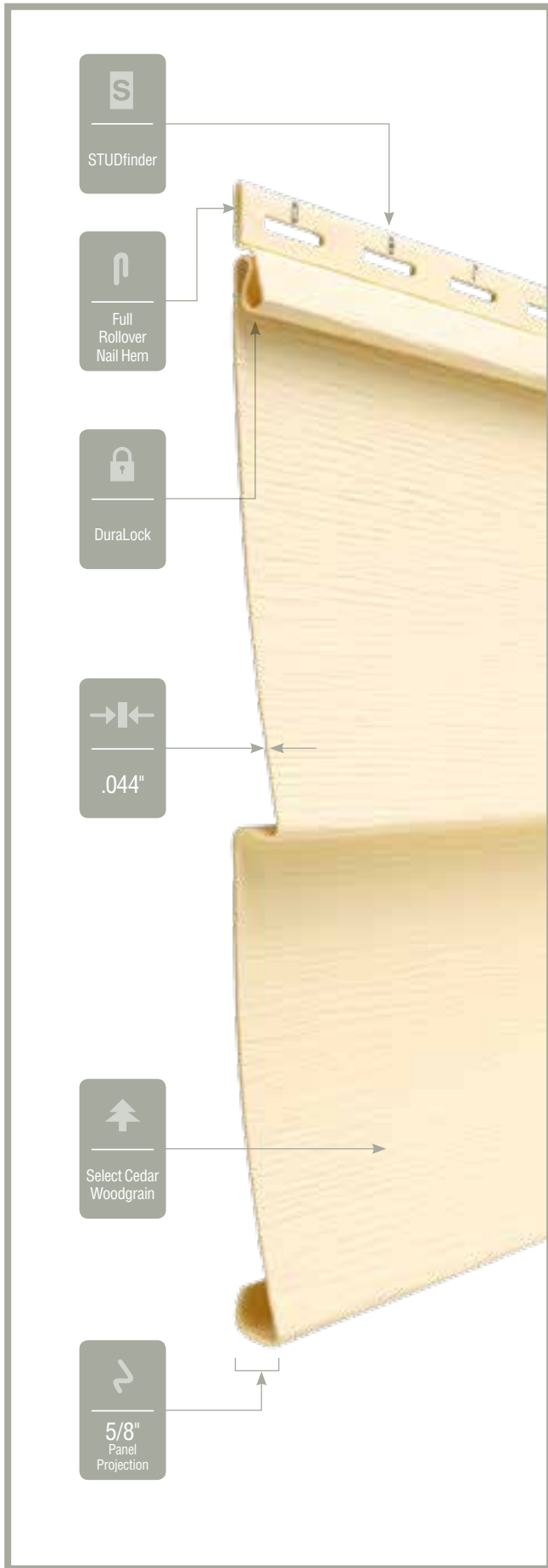

	D4 Clapboard	D4 ^{1/2} Dutchlap	D5 Clapboard	D4 ^{1/2} Clapboard	T3 Clapboard	
Autumn Red*	●	●				
Terra Cotta*	●					
Mountain Cedar*	●					
Sable Brown*	●					
Hearthstone*	●					
Suede	●	●				
Spruce*	●					
Forest*	●	●				
Pacific Blue*	●					
Flagstone*	●					
Charcoal Gray*	●	●				
Granite Gray	●	●	●	●	●	
Sterling Gray	●	●	●	●	●	
Oxford Blue	●	●	●	●	●	
Seagrass	●	●	●			
Cypress	●	●	●	●	●	
Linen	●	●	●			
Herringbone	●	●	●	●	●	
Sandstone Beige	●	●	●	●	●	
Desert Tan	●	●	●	●	●	
Natural Clay	●	●	●	●	●	
Savannah Wicker	●	●	●	●	●	
Light Maple	●	●	●	●	●	
Buckskin	●	●				
Heritage Cream	●	●	●	●	●	
Autumn Yellow	●	●	●			
Snow	●	●	●	●	●	
Colonial White	●	●	●	●	●	

*Deluxe Colors



Siding: Restoration Classic Double 4" Clapboard in linen.
 Trim: Vinyl Carpentry® & Restoration Millwork®.

Carolina Beaded™



.044"



1



14



up to
190_{mph}



Standard
Nail Hem



3/4"
Panel
Projection



Brushed



Post-formed



Lifetime
Limited
Warranty



STUDfinder



Class A
Flame Spread



PermaColor
Fade
Protection



Low
Maintenance



Siding: Carolina Beaded in heritage cream.
Trim: Vinyl Carpentry® & Restoration Millwork®.

Single 6-1/2"
Brushed Beaded



granite gray

PANEL DIMENSIONS

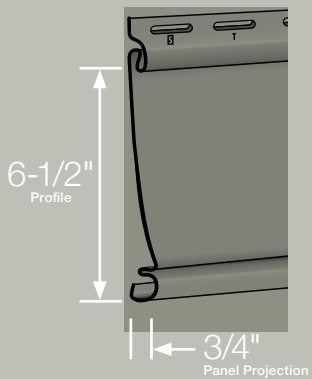

Available Lengths: 12' 4"

S6^{1/2}
Beaded

Granite Gray	●	
Sterling Gray	●	
Oxford Blue	●	
Cypress	●	
Silver Ash	●	
Herringbone	●	
Sandstone Beige	●	
Desert Tan	●	
Natural Clay	●	
Savannah Wicker	●	
Light Maple	●	
Heritage Cream	●	
Snow	●	
Colonial White	●	

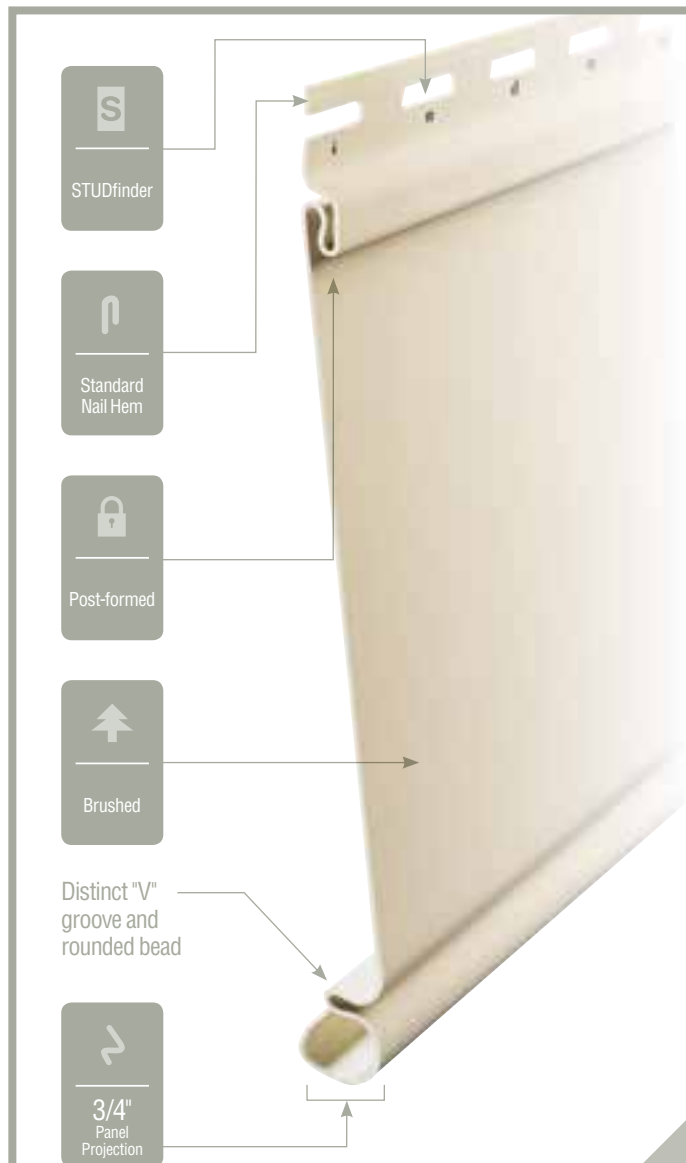

MainStreet™

 .042"	 7	 24	 up to 200mph	 Partial Rollover Nail Hem	 9/16" Panel Projection	 Woodgrain & Brushed	 DuraLock	 Lifetime Limited Warranty	 STUDfinder	 Class A Flame Spread	 PermaColor Fade Protection	 Low Maintenance
---	--	---	--	--	---	---	---	--	--	--	---	---



Siding: MainStreet Double 4" Clapboard in hearthstone.
Trim: Vinyl Carpentry® & Restoration Millwork®.





Triple 3"
Brushed
Clapboard

light maple



Double 4"
Woodgrain
Clapboard

natural clay



Double 5"
Woodgrain
Clapboard

silver ash

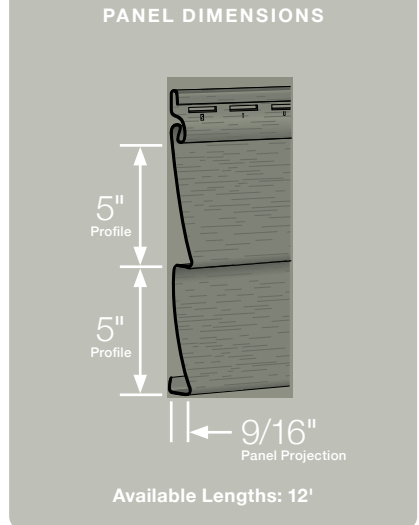
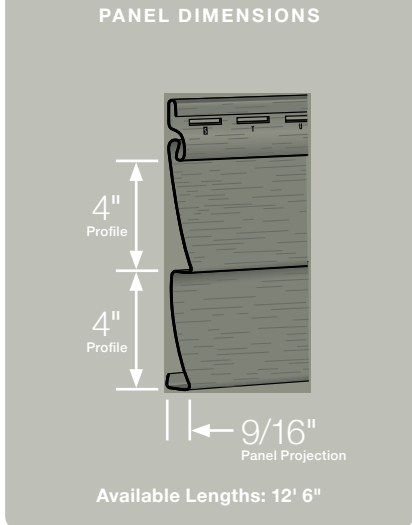
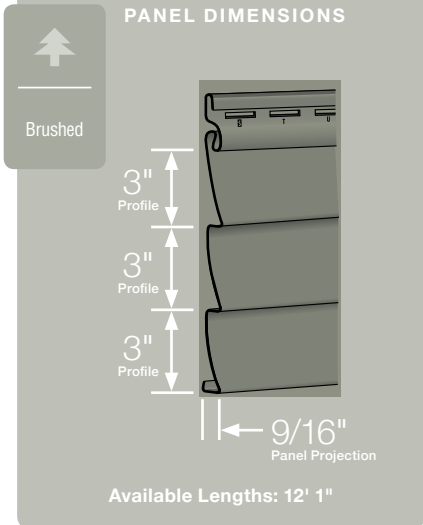

Double 4"
Woodgrain
Dutchlap

granite gray

Double 5"
Woodgrain
Dutchlap

forest

Single 6-1/2"
Brushed Beaded

oxford blue

Single 8"
Woodgrain
Clapboard

colonial white

PANEL DIMENSIONS

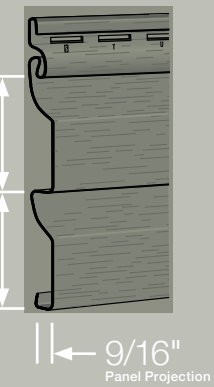

Available Lengths: 12' 6"

PANEL DIMENSIONS

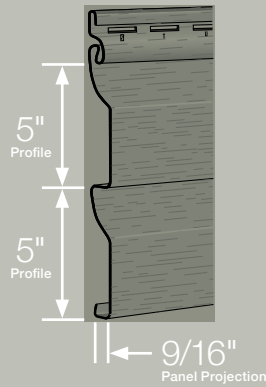

Available Lengths: 12'



Brushed

PANEL DIMENSIONS

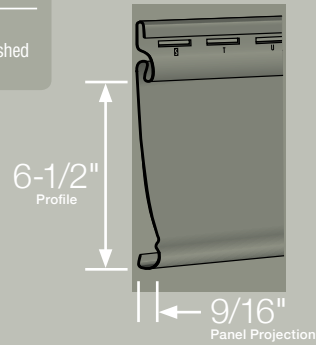

Available Lengths: 12' 4"

PANEL DIMENSIONS

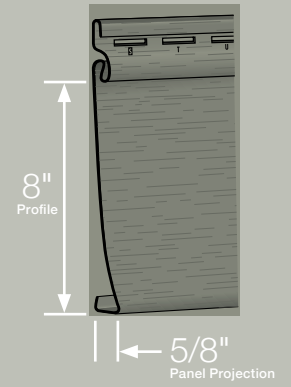

Available Lengths: 12' 6"

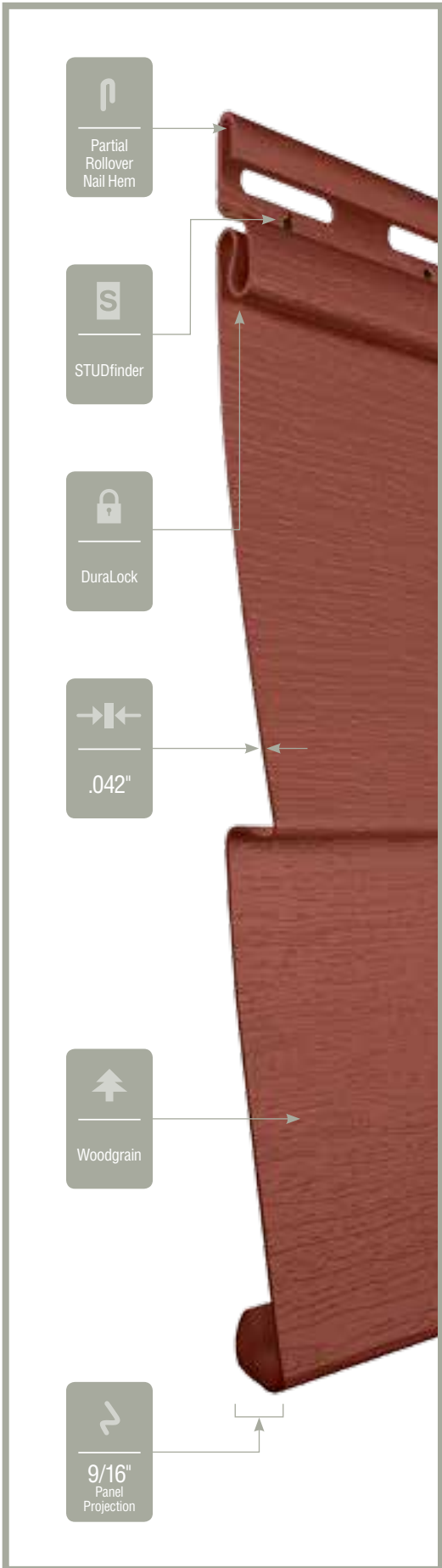

	T3 Clapboard	D4 Clapboard	D5 Clapboard	D4 Dutchlap	D5 Dutchlap	S6 ^{1/2} Beaded	S8 Clapboard
Autumn Red*		●	●	●	●		
Hearthstone*		●	●	●	●		
Suede		●	●	●	●		
Spruce*		●	●	●	●		
Forest*		●	●	●	●		
Flagstone*		●	●	●	●		
Charcoal Gray*		●	●	●	●		
Granite Gray		●	●	●	●	●	
Sterling Gray	●	●	●	●	●	●	
Oxford Blue	●	●	●	●	●	●	
Seagrass		●	●	●	●		
Cypress		●	●	●	●	●	
Silver Ash	●	●	●	●	●	●	
Sandstone Beige	●	●	●	●	●	●	
Desert Tan	●	●	●	●	●	●	
Natural Clay	●	●	●	●	●	●	
Savannah Wicker	●	●	●	●	●	●	
Light Maple	●	●	●	●	●	●	
Buckskin		●	●	●	●		
Sandpiper	●	●	●	●	●		
Heritage Cream		●	●	●	●	●	
Autumn Yellow		●	●	●	●		
Snow	●	●	●	●	●	●	
Colonial White	●	●	●	●	●	●	●

*Deluxe Colors



Siding: MainStreet Double 4" Clapboard in cypress.
 Accents: Cedar Impressions Half-Round Shingles in colonial white, natural clay and ivy green.
 Trim: Vinyl Carpentry® & Restoration Millwork®.



Siding: MainStreet Double 4" Clapboard in flagstone.
Trim: Vinyl Carpentry® & Restoration Millwork®.

Wolverine American Legend™



.042"



3



22



up to
180mph



Standard
Nail Hem



9/16"
Panel
Projection



Woodgrain



GripLock



Lifetime
Limited
Warranty



STUDfinder



Class A
Flame Spread



PermaColor
Fade
Protection



Low
Maintenance



Siding: American Legend Double 4" Clapboard in buckskin.
Trim: Vinyl Carpentry® & Restoration Millwork®.

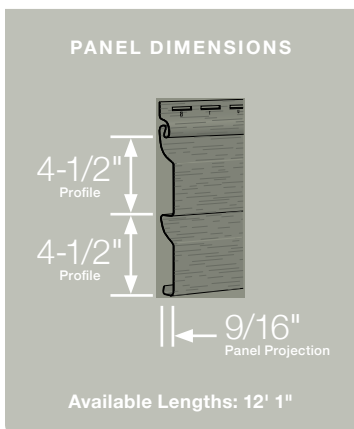
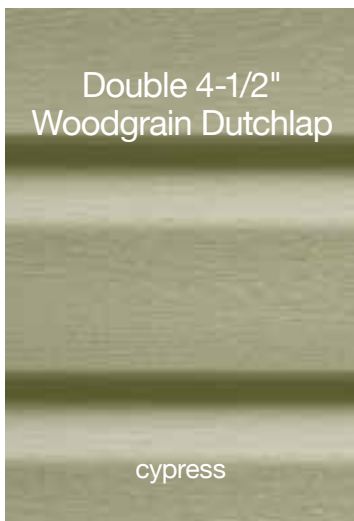
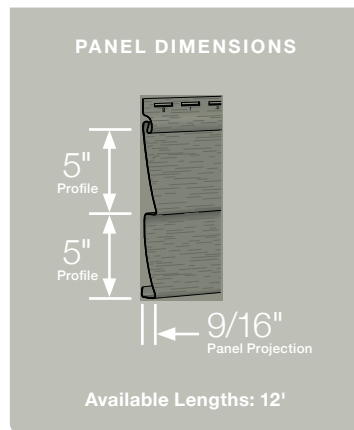
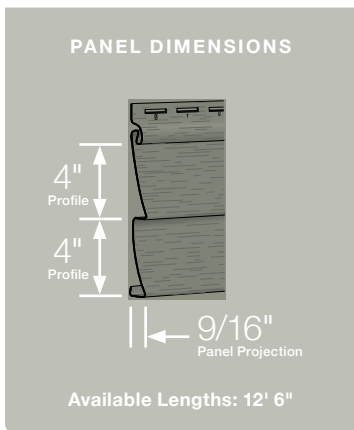
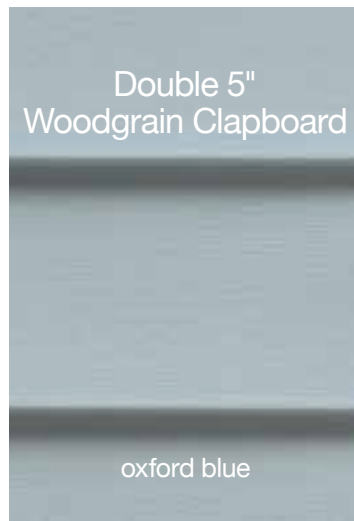
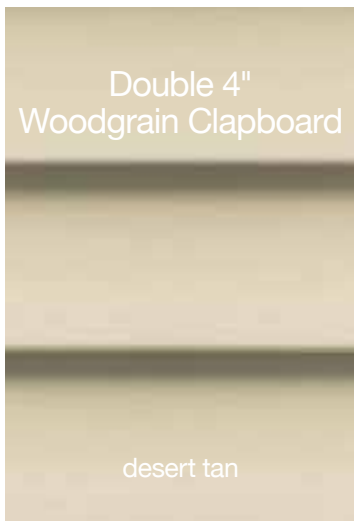

*Deluxe Colors

	D4 Clapboard	D5 Clapboard	D4 ^{1/2} Dutchlap	
Autumn Red*	●	●	●	
Hearthstone*	●	●	●	
Spruce*	●	●	●	
Forest*	●	●	●	
Flagstone*	●	●	●	
Charcoal Gray*	●	●	●	
Granite Gray	●	●	●	
Sterling Gray	●	●	●	
Oxford Blue	●	●	●	
Seagrass	●	●	●	
Cypress	●	●	●	
Warm Sand	●	●	●	
Herringbone	●	●	●	
Desert Tan	●	●	●	
Natural Clay	●	●	●	
Savannah Wicker	●	●	●	
Light Maple	●	●	●	
Buckskin	●	●	●	
Heritage Cream	●	●	●	
Autumn Yellow	●	●	●	
Snow	●	●	●	
Colonial White	●	●	●	

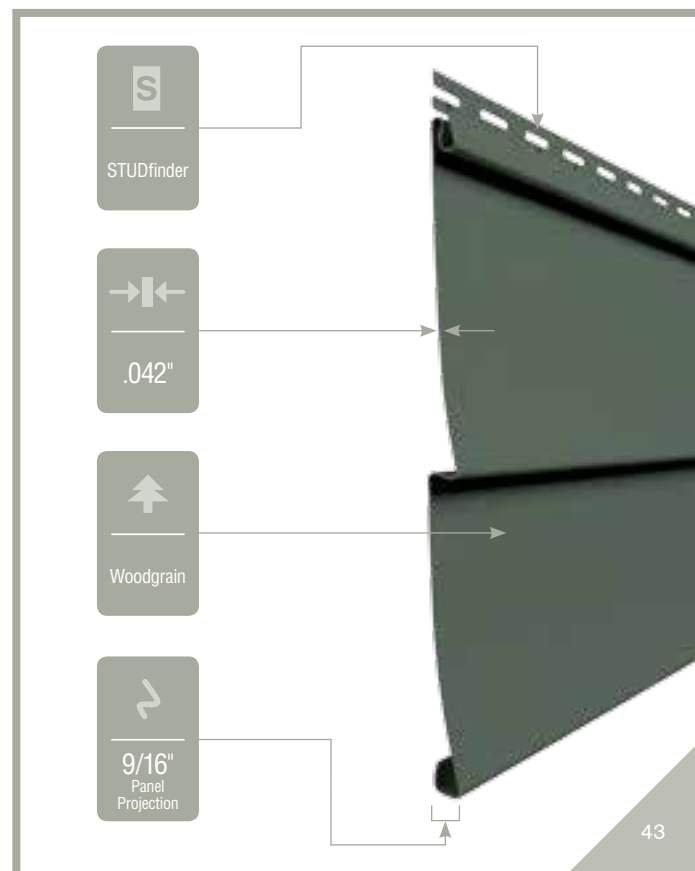

Encore™

 .040"	 4	 16	 up to 175mph	 Partial Rollover Nail Hem	 1/2" Panel Projection	 Woodgrain	 Post-formed	 Lifetime Limited Warranty	 STUDfinder	 Class A Flame Spread	 PermaColor Fade Protection	 Low Maintenance
---	--	---	--	--	--	--	--	--	--	--	---	---



Siding: Encore Double 4" Clapboard in castle stone.
Trim: Vinyl Carpentry® & Restoration Millwork®.

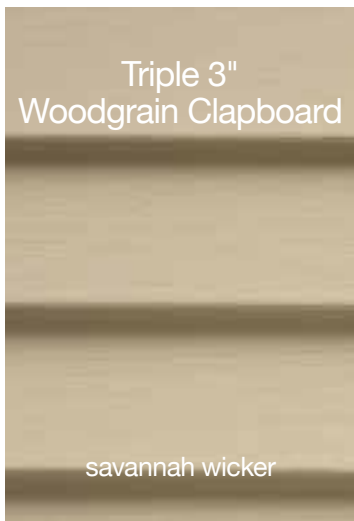

Triple 3"
Woodgrain Clapboard

savannah wicker

PANEL DIMENSIONS

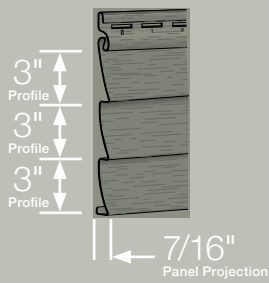

Available Lengths: 12' 1"

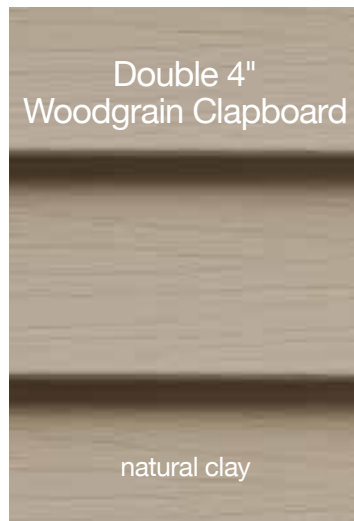

Double 4"
Woodgrain Clapboard

natural clay

PANEL DIMENSIONS

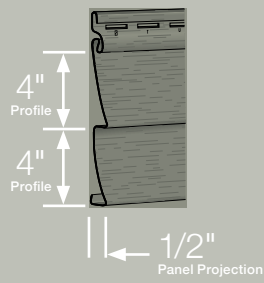

Available Lengths: 12' 6"

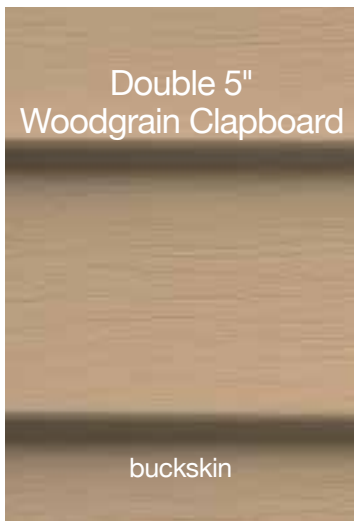

Double 5"
Woodgrain Clapboard

buckskin

PANEL DIMENSIONS

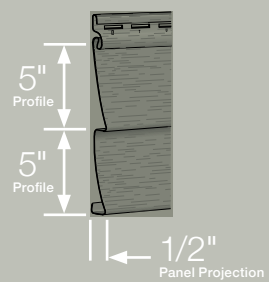

Available Lengths: 12'

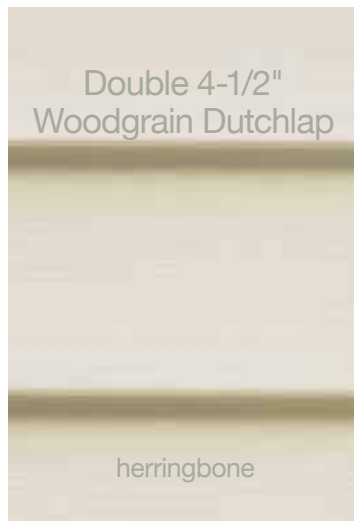

Double 4-1/2"
Woodgrain Dutchlap

herringbone

PANEL DIMENSIONS

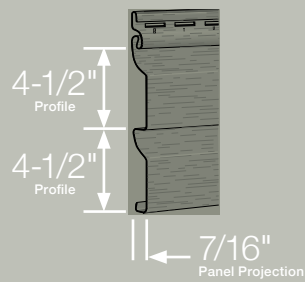





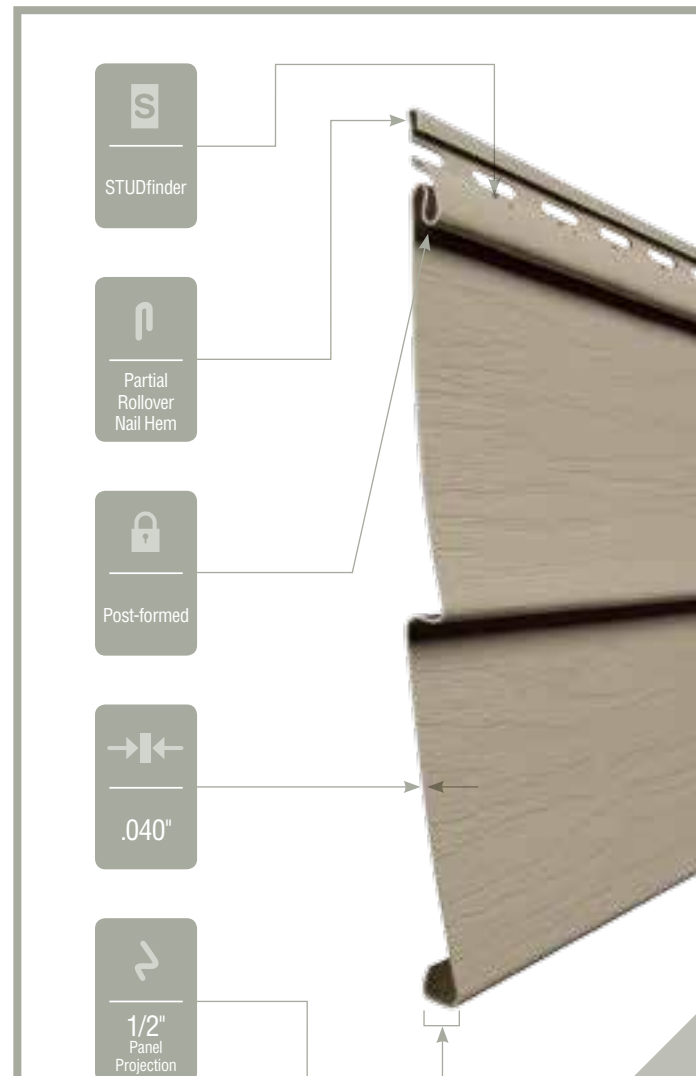





Available Lengths: 12' 1"

	T3 Clapboard	D4 Clapboard	D5 Clapboard	D4 ^{1/2} Dutchlap	
Castle Stone		●	●	●	New Color
Sterling Gray	●	●	●	●	
Oxford Blue	●	●	●	●	
Seagrass		●	●	●	New Color
Cypress		●	●	●	
Natural Clay	●	●	●	●	
Warm Sand	●	●	●	●	
Herringbone	●	●	●	●	
Sandstone Beige	●	●	●	●	
Desert Tan	●	●	●	●	
Savannah Wicker	●	●	●	●	
Light Maple	●	●	●	●	
Buckskin		●	●	●	New Color
Heritage Cream	●	●	●	●	
Snow	●	●	●	●	
Colonial White	●	●	●	●	



Board & Batten

 .048"	 1	 12	 up to 190 _{mph}	 Standard Nail Hem	 1/2" Panel Projection	 TrueTexture	 Lifetime Limited Warranty	 Class A Flame Spread	 PermaColor Fade Protection	 Low Maintenance
---	--	---	--	---	--	--	--	--	--	---



Siding: Board & Batten in herringbone and Cedar Impressions
Double 9" Staggered Rough-Split Shakes in sable brown.
Trim: Vinyl Carpentry® & Restoration Millwork®.



S8 Board & Batten	
Granite Gray	●
Sterling Gray	●
Cypress	●
Herringbone	●
Sandstone Beige	●
Desert Tan	●
Natural Clay	●
Savannah Wicker	●
Light Maple	●
Heritage Cream	●
Snow	●
Colonial White	●

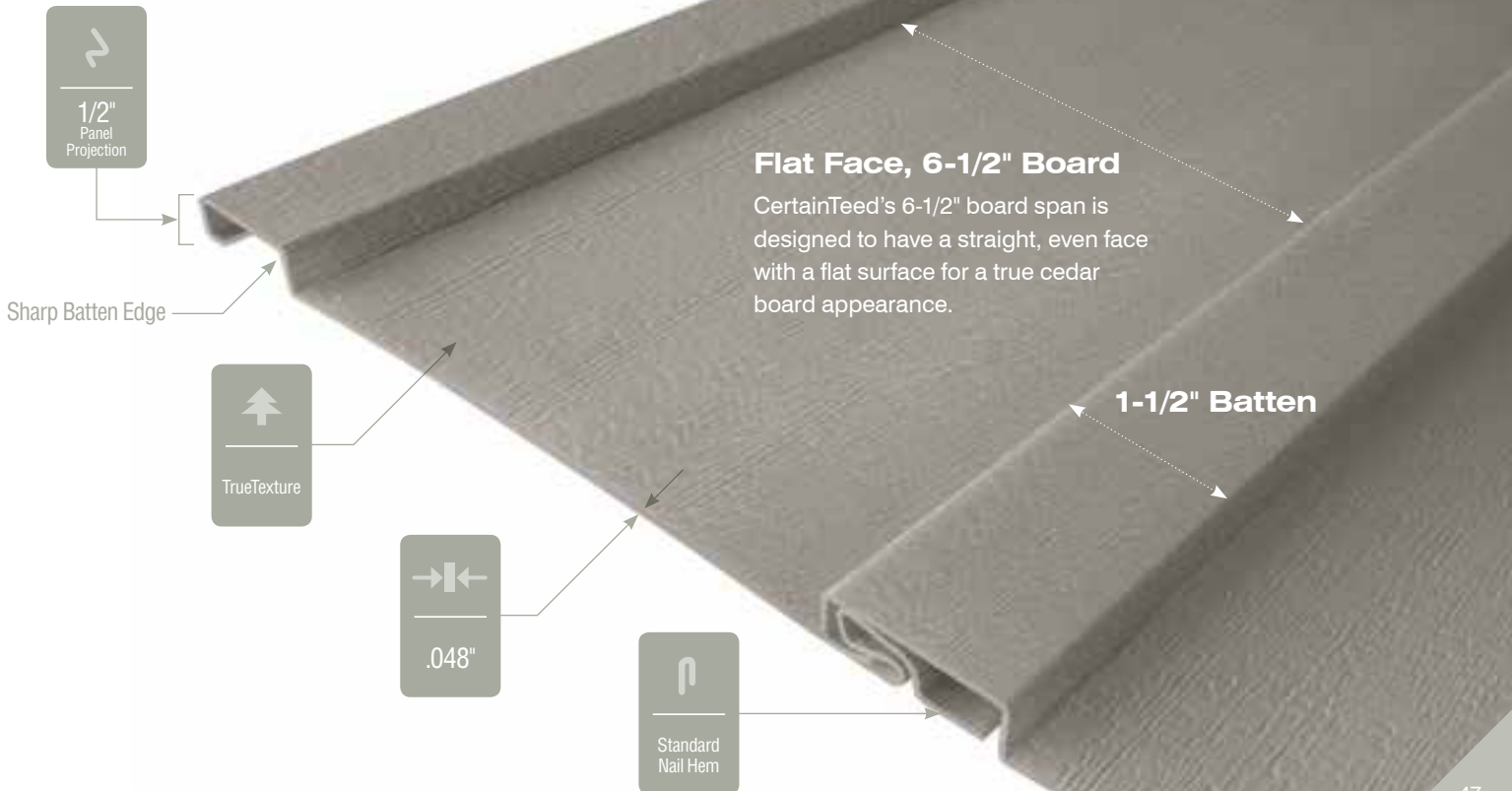
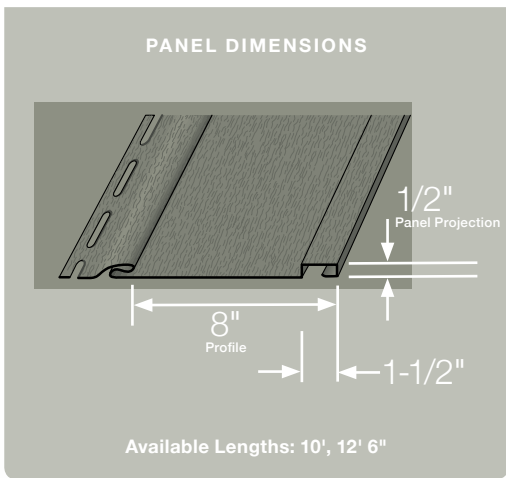

Flat Face, 6-1/2" Board
 CertainTeed's 6-1/2" board span is designed to have a straight, even face with a flat surface for a true cedar board appearance.

Chamfer Board™

Vertical Siding & Soffit



.044"



1



8



up to
140_{mph}



Standard
Nail Hem



9/16"
Panel
Projection



Brushed



Lifetime
Limited
Warranty



Class A
Flame Spread



PermaColor
Fade
Protection



Low
Maintenance



Siding: Chamfer Board™ in colonial white.
Trim: Vinyl Carpentry® & Restoration Millwork®.



Double 5"
Brushed Solid

savannah wicker



Double 5"
Brushed Fully Vented

granite gray

D5
Solid and
Fully Vented

Granite Gray	●	
Sterling Gray	●	
Cypress	●	
Natural Clay	●	
Savannah Wicker	●	
Light Maple	●	
Heritage Cream	●	
Colonial White	●	

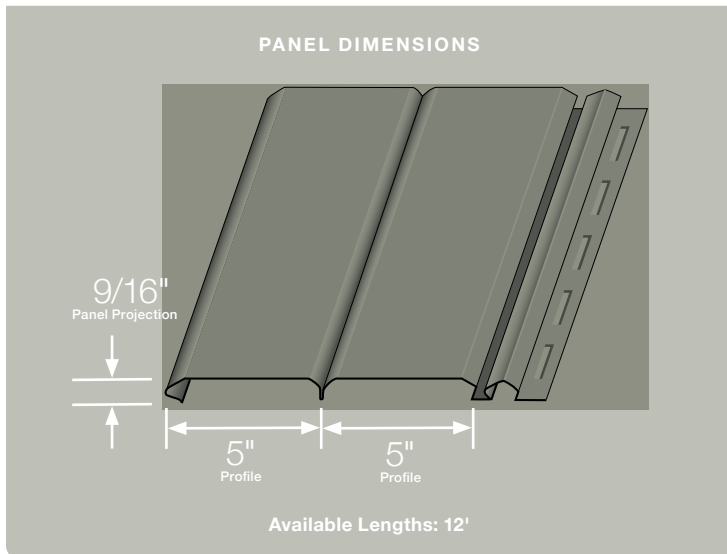

"V" Groove



Triple 3-1/3" Soffit & Vertical Siding

- InvisiVent® and solid styles.
- The only vinyl soffit to provide more than 10 inches of net-free intake area.
- Concealed intake vents provide a smooth appearance.
- Matte finish looks like freshly painted wood.
- Deep 3/4" panel projection creates sharp definition.
- 13 low-gloss colors.
- Heavy-duty .044" thickness for rigidity.

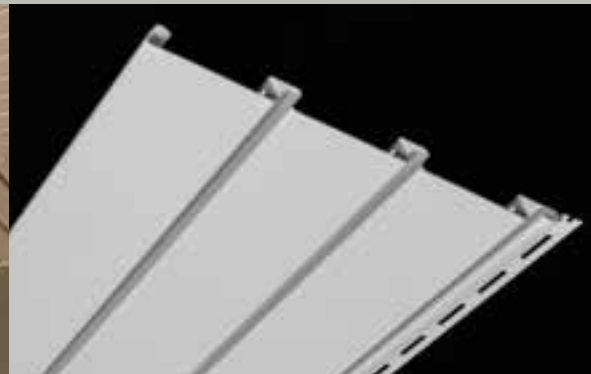

Perimeter™ Triple 3-1/3" Soffit & Vertical Siding

- Solid and hidden vent styles.
- 14 low-gloss colors.
- .040" thickness.
- Hidden vent style provides up to 9.65" of net-free intake area.

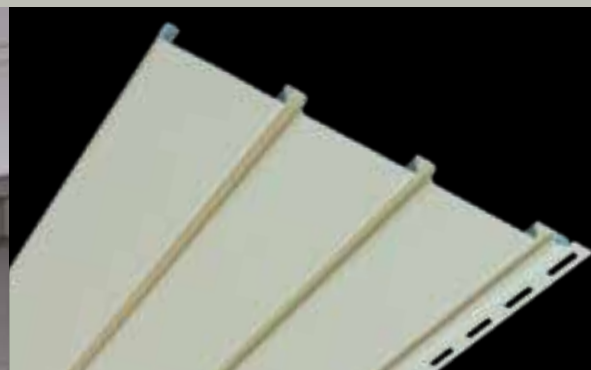

Beaded Triple 2" Soffit & Vertical Siding

- Wainscot style in solid and invisibly vented.
- Designed for vertical siding, porch ceiling and soffit applications.
- Smooth finish of professionally applied paint.
- Extra-long slip-lock design helps provide secure installation.
- 8 low-gloss colors.
- .039" thickness.
- 1.6" of net-free air per sq. ft. - invisibly vented.





Triple 3-1/3" InvisiVent

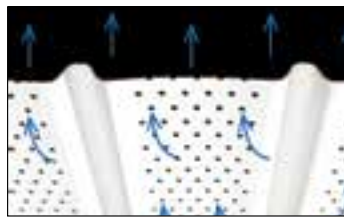

Standard vented soffit

Hidden vents provide a smooth, flat non-perforated surface versus most vented soffits with unsightly perforations.



Triple 3-1/3" InvisiVent offers at least 50% more ventilation than most standard vinyl soffit, providing more than 10" of net-free intake area. This means that not only will InvisiVent provide a balanced ventilation system, but will do so with an overhang as short as 10".

	T3 ^{1/3} Solid and InvisiVent	T3 ^{1/3} Perimeter	T2 Beaded	
Charcoal Gray		●		
Granite Gray	●	●		
Sterling Gray	●	●	●	
Seagrass	●	●		
Cypress	●	●		
Herringbone	●	●		
Sandstone Beige	●	●	●	
Desert Tan	●	●	●	
Natural Clay	●	●	●	
Savannah Wicker	●	●	●	
Light Maple	●	●		
Heritage Cream	●	●	●	
Snow	●	●	●	
Colonial White	●	●	●	

Proper Ventilation is Critical

Soffit Vents (intake)

Protection against damage to the roofing materials and structure increase comfort inside the home and energy savings.

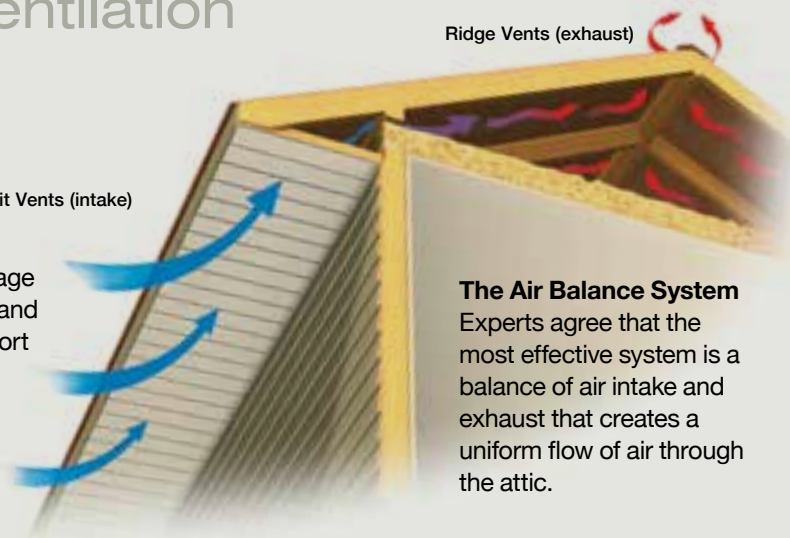

Ridge Vents (exhaust)

The Air Balance System
Experts agree that the most effective system is a balance of air intake and exhaust that creates a uniform flow of air through the attic.

This system creates a condition in which the roof temperature is equalized from top to bottom, supplying a uniform air flow along the entire underside of the roof deck.



Beaded Triple 2" in colonial white.



Beaded Triple 2" in natural clay.

Ironmax™ Double 5" Soffit & Vertical Siding

- Solid and fully vented styles.
- Extra-thick .046" construction for optimum strength and flat face appearance.
- Designed for vertical siding, porch ceiling and soffit applications.
- Unique post-formed lock design helps ensure secure installation.
- 32 low-gloss woodgrain colors (sable brown, pacific blue, ivy green, autumn red, charcoal gray and forest for soffit applications only).
- 6.4" of net-free air per sq. ft.- fully vented.



Universal Triple 4" Soffit & Vertical Siding

- Solid, fully vented and center vented styles.
- Designed for vertical siding, porch ceiling and soffit applications.
- Matte finish.
- Post-formed lock design helps provide secure installation.
- 35 low-gloss colors (center vented: colonial white and snow only).
- .040" thickness.
- 5.9" of net-free air per sq.ft. - fully vented.
- 2" of net-free air per sq. ft. - center vented.

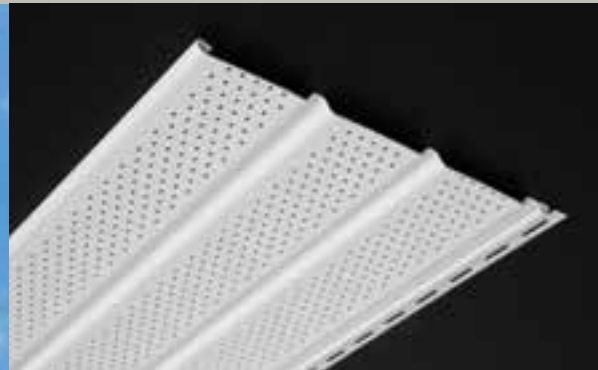

Value Triple 4" & Double 5" Soffit

- Solid, fully vented and center vented styles.
- For use in new construction and remodeling.
- Post-formed lock design helps provide secure installation.
- Triple 4 - 9 low-gloss colors (center vented: colonial white and snow only).
- Double 5 - 5 low-gloss colors.

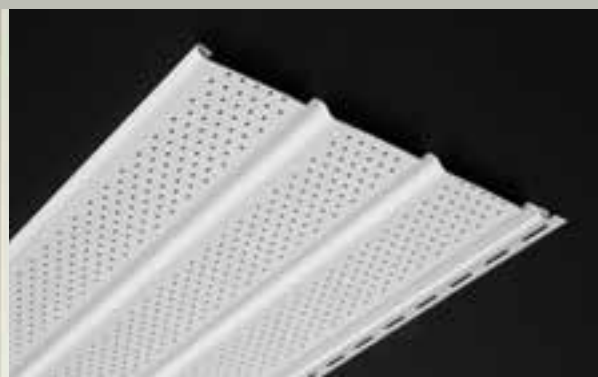



Ironmax Double 5" in colonial white.



Universal Triple 4" in colonial white.
Carolina Beaded in natural clay.

	D5 Ironmax	T4 Universal	T4 Value	D5 Value
Arbor Blend**	●			
Arctic Blend**	●			
Weathered Blend**	●			
Frontier Blend**	●			
Timber Blend**	●			
Canyon Blend*	●			
Meadow Blend*	●			
Glacier Blend*	●			
Musket Brown**		●		
Autumn Red	●	●		
Terra Cotta		●		
Mountain Cedar		●		
Sable Brown	●	●		
Hearthstone		●		
Suede		●		
Spruce		●		
Forest	●	●		
Ivy Green	●	●		
Pacific Blue	●	●		
Flagstone		●		
Charcoal Gray	●	●		
Castle Stone		●		
Granite Gray	●	●		
Sterling Gray	●	●	●	●
Bermuda Blue		●		
Oxford Blue	●	●		
Seagrass	●	●		
Cypress	●	●		
Green Tea		●		
Linen	●	●		
Silver Ash	●	●		
Warm Sand	●	●		
Herringbone	●	●	●	
Sandstone Beige	●	●		
Desert Tan	●	●	●	●
Natural Clay	●	●	●	●
Savannah Wicker	●	●	●	●
Light Maple	●	●	●	
Buckskin	●	●		
Sandpiper		●		
Heritage Cream	●	●	●	
Autumn Yellow		●		
Snow	●	●	●	
Colonial White	●	●	●	●

*Deluxe Colors
**Premium Colors

Vinyl Carpentry®

Decorative Trim

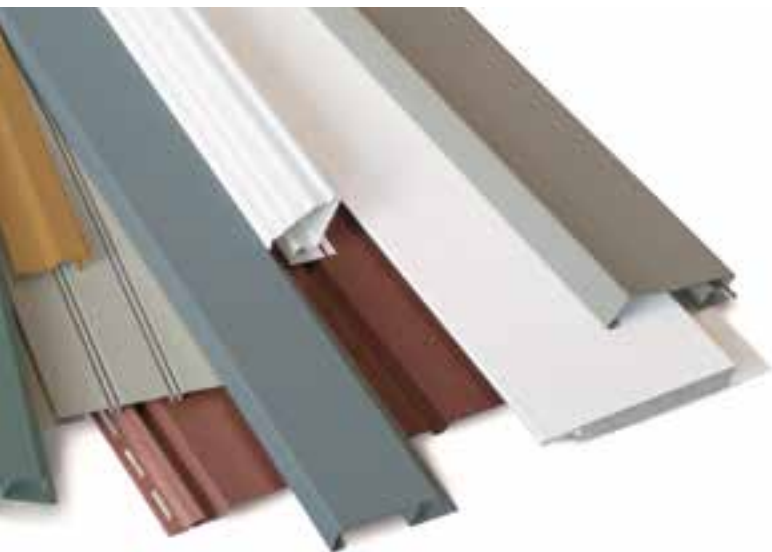

Vinyl Carpentry®

Vinyl Carpentry trim offers you a wide array of decorative design possibilities to accent your home's exterior. Replicate the look of real wood with a wonderful assortment of styles and colors – and they never need painting.

- Designed to add distinction to windows, doors, corners, gables and frieze boards.
- Authentic painted wood look.
- New construction and remodeling installation flexibility.
- Wide variety of colors to coordinate with siding.
- Color-clear-through construction means scratches won't show.
- Virtually maintenance free, never needs painting.

Create the look of true wood craftsmanship with a complete line of decorative accents and trim pieces for both new construction and remodeling.

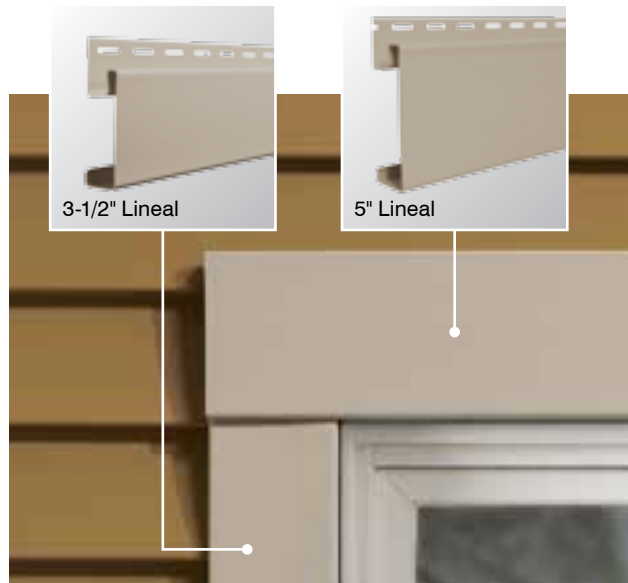

Window & Door Trim

- Crown Molding
- Corner Block & Rosette
- J-Channels
- Snap-OnLineal
- Lineals

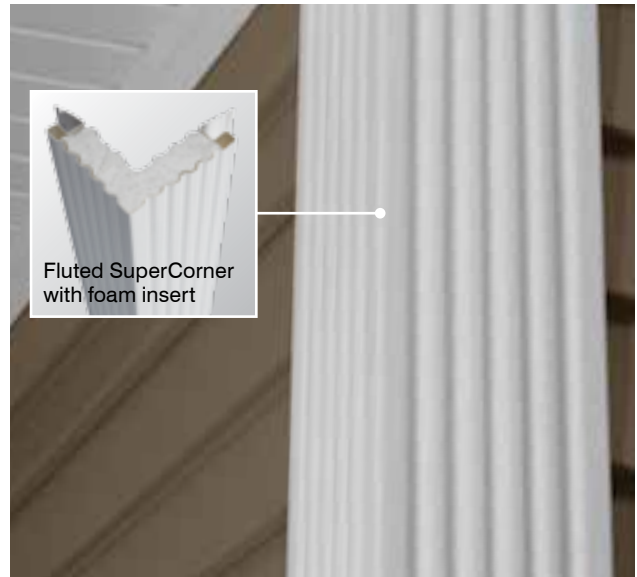

Corner Systems

- Outside Corner Posts
- Insulated Corner Posts
- Inside Corner Posts
- Mitered Corner Posts
- SuperCorners™
- Corner Cap
- Bay Window Corner Posts
- 4-Piece Corner Systems



Accents

- Cedar Impressions®
- Board & Batten



Wall & Soffit Transitions

- Cornice Molding
- Finish Board
- Band Board
- Double Channel Lineals
- Soffit Cove Trim
- H-Bars
- Lineals

Restoration Millwork®

Exterior Trim

The Ultimate Finish!

- Superior quality and excellent dimensional accuracy.
- Low-maintenance and long-lasting UV-resistant material.
- Natural white and ready to install.
- Can be painted* to complement with exterior colors.
- Cuts and mills with traditional woodworking tools.
- Class A (Class 1) Flame Spread Classification.
- Meets ICC and CCMC code requirements.
- Made in U.S.A.
- GreenCircle Certified - contains recycled content.
- 25-year limited warranty.

*See Installation Guidelines RM003 for painting instructions.



InvisiPro™ Hidden Fastening System

Trimboards feature grooved millwork that precision-fits to flanges secured directly to the wall, working together with both nail hem flange and starter flange for a secure fit. The flanges are concealed, leaving only a face nail-free installation with no nail holes to fill.

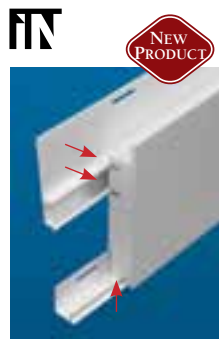

iNhanced™ TRIM LINE

INspired designs that enhance aesthetics. INnovative engineering that improves performance. INtegral components that speed installation. This collection of decorative components delivers extraordinary advantages from the inside out. Hidden flanges, built-in J-pockets, pre-assembled column wraps and one-piece corners enable easy installation, while authentic finishes create in an incredible natural wood appearance.

iN Look for the IN to identify CertainTeed's iNhanced products.

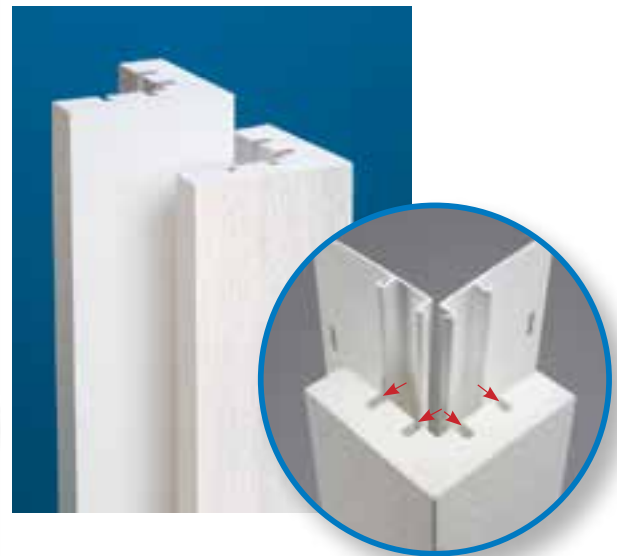

One-Piece Corner and Nail Hem Flange **iN**

Corners are now designed to be installed with or without a nailing flange. As part of the InvisiPro™ Hidden Fastening System, a nailing flange is a quick and easy way of securing corners – avoiding any face nailing of the corner.

- Hidden attachment points.
- Secures tightly to wall with screws.
- Installs before siding.
- Corners can still be used without flange.

Specialty Profiles



#45, 47, 49 Crown

Brickmould

J-Channel Brickmould

Back Band

RB3 Casing

356 Casing

Sill

Adjustable Back Band

Base Cap

Drip Cap

Shingle Mould

Bed Mould

Inside Corners

Rake

Rams Crown

Sill Nose

Lattice

Historic Sill

Quarter Round

Cove Moulding

Column Wraps

Slides On, Swings Closed for Fast, Easy Installation

A three-sided wrap with a swinging door on the fourth side, Column Wraps are pre-cut, pre-mitered, and pre-assembled to slide around existing wood load-bearing 4 in. x 4 in. or 6 in. x 6 in. porch posts.

Simple and versatile, with 2 column sizes: 8 in. x 8 in. and 10 in. x 10 in. square.



Estate cap/base

Classic cap/base



J-Pockets and Cut-Outs

Restoration Millwork trimboards with built-in J-pocket eases installation of corner trim and the cut-out allows the trimboard to lie flush with the siding around windows and doors with built-in nail flanges.

Beadboard with TightLap™

Whether you choose 2TL or 3TL, Beadboard with TightLap is designed to have a larger nailing area with the security of tongue and groove.



Beadboard with TightLap™

3TL Beadboard— a full 1/3 wider for faster coverage.



Fascia Trimboard

Fascia trimboard with built-in return leg is designed to work with a wide range of soffit materials. Available in TrueTexture™ and smooth finish.



Sheets

Available in a full selection of custom and standard sizes and shapes, sheets can be used to create distinctive, one-of-a-kind exterior elements that are as beautiful as they are durable.



Skirtboard with DualStart® Design

Engineered with DualStart® Design (patent-pending) cuts installation time while providing the 6 in. ground clearance required by U.S. building codes for fiber cement siding.

CustomCraft™

Restoration Millwork CustomCraft boards and sheets for custom fabrication feature extra thickness, so they reduce time and labor costs related to laminating and creating custom designs. CustomCraft Sheets are available in 1-1/2 in. x 4 ft. x 8 ft.



Finishing Touches



Certa-Snap® Wrap Post Wrap System



3-1/2" Cornerpost



J-Channel

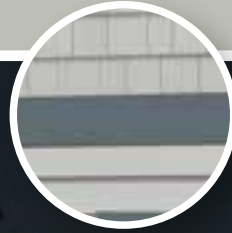

Restoration Millwork trimboard*



3-1/2" Lineal with miter cut corners



3-1/2" Cornerpost

Subtle



Siding: CedarBoards™ Single 7" in sterling gray.
 Trim: Vinyl Carpentry® in white and sterling gray.
 Roofing: Landmark® Shingles in georgetown gray.

Bold



Siding: CedarBoards Single 7" and Cedar Impressions Double 7" Straight Edge Perfection Shingles in sterling gray.
 Trim: Vinyl Carpentry® & Restoration Millwork® in pacific blue.
 Roofing: Landmark® Shingles in georgetown gray.

* Restoration Millwork painted with Sherwin-Williams® color safe paint.

Details Create the Personality

Here are just a few of many ideas for finishing gables, windows, corners, columns, railings, porches and more. With CertainTeed exterior products, there are no limits to the unique personality you can create. And by adding just the right balance of details, you are improving the curb appeal and value of your home.



Panorama® composite railing, white with steel straight balusters in antique bronze

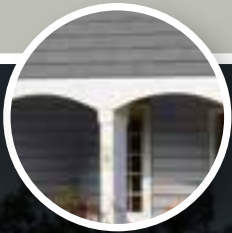

Restoration Millwork Classic Column Wraps

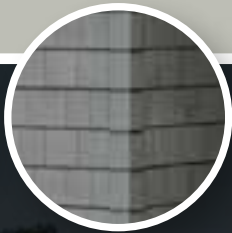

Cedar Impressions Perfection Mitered Cornerpost



Vinyl Carpentry Cornice Molding and Restoration Millwork Rake Profile



Restoration Millwork Trimboard with Rams Crown



Restoration Millwork One-Piece Corner with InvisiPro Hidden Fastening System

Contrasting



Siding: CedarBoards Single 7" in sterling gray and Cedar Impressions Double 7" Straight Edge Perfection Shingles in charcoal gray.

Trim: Vinyl Carpentry® & Restoration Millwork® in colonial white.

Roofing: Landmark Shingles in georgetown gray.

UnderShield®

Water Diversion System



UnderShield® turns an unsightly deck underside into a dry, beautiful ceiling, creating limitless options for new exterior living spaces.

New Possibilities for the Home

A beautiful deck is easy to love, from the top. Now, you can love your deck from underneath as well, with the beautiful possibilities of UnderShield.

A unique, vinyl shield and ceiling system designed to respond to the needs of building professionals and homeowners, UnderShield is easy to install to new or existing decks, and will maintain unobstructed air flow when properly installed. Panels can run parallel or perpendicular to the home, and an easy-to-use clip creates the desired pitch.



Savannah Wicker



Sterling Gray



Colonial White

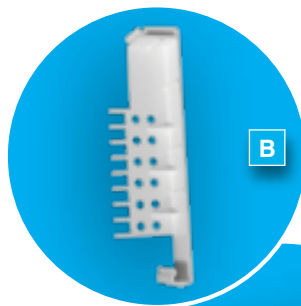

B Clip System comes with all stainless steel hardware (not shown)



C Vinyl Grid System

UnderShield is available in beaded or chamfer panels (A). System also includes clips (B), grid system (C), fascia panels and stainless steel hardware (not shown).

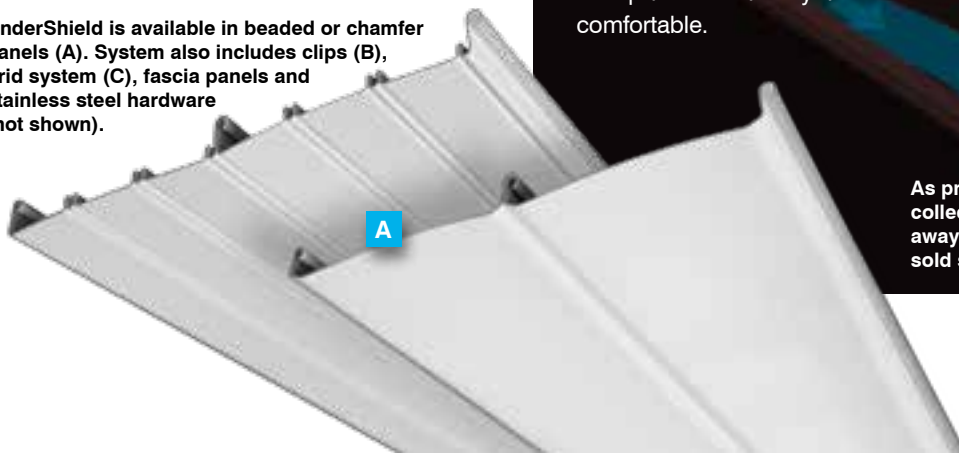

A

- Low maintenance water diversion system.
- Easy to install adjustable grid system.
- Concealed clip system.
- Stainless steel hardware provides security and lasting performance.
- High quality vinyl panels available in 6"x 16'.
- Choice of 2 panel styles and 3 colors.
- Suitable for one and two-story residential applications.
- Installs under the deck joist - no need to worry if the framing is 12" or 16" on center.
- Helps maintain the required ventilation under the deck for most composite deck boards.
- Since it installs under the framing, there is no need to worry about any bracing that may have been installed between joists.
- Class A Flame Spread rating.
- Lifetime limited warranty.

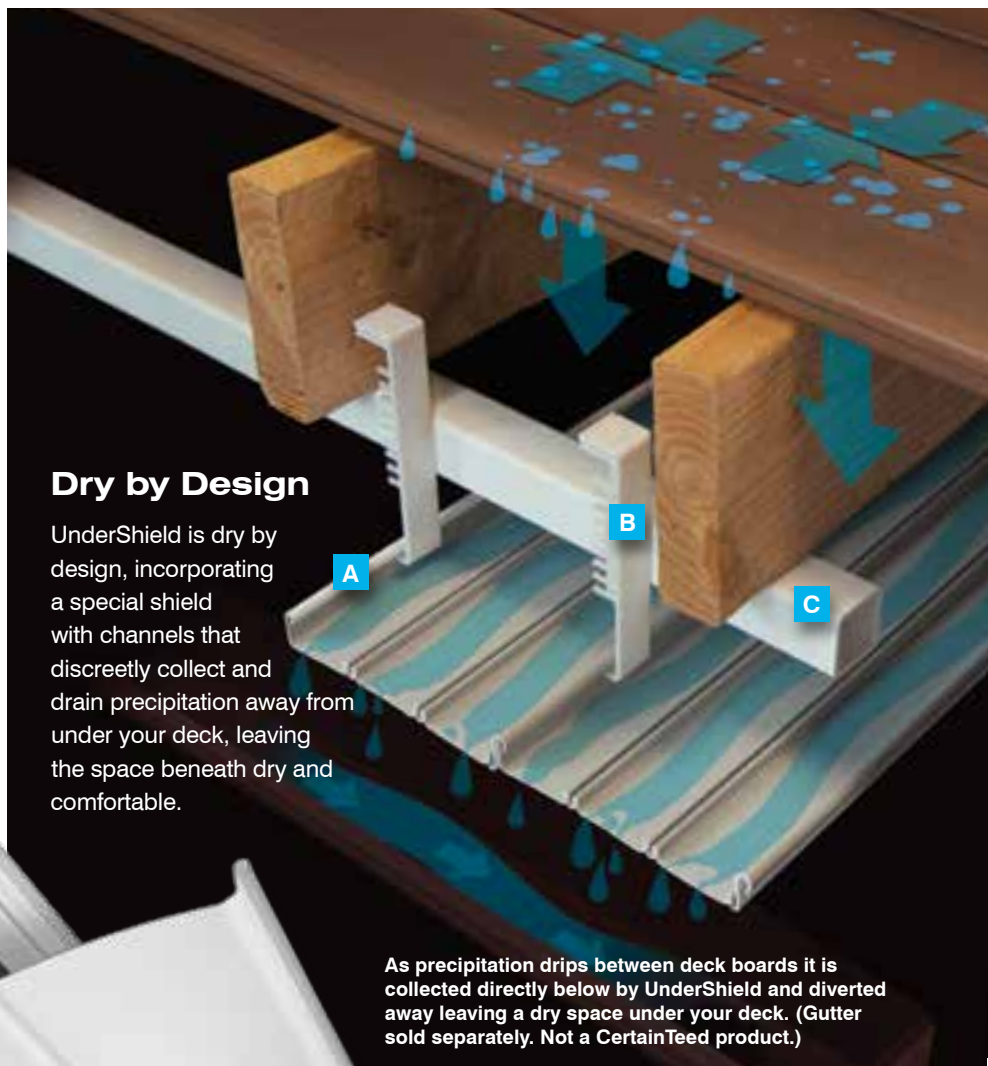

Dry by Design

UnderShield is dry by design, incorporating a special shield with channels that discreetly collect and drain precipitation away from under your deck, leaving the space beneath dry and comfortable.

As precipitation drips between deck boards it is collected directly below by UnderShield and diverted away leaving a dry space under your deck. (Gutter sold separately. Not a CertainTeed product.)

CertaWrap™

Weather Resistant Barrier



CertaWrap Accessories

For maximum effectiveness, it's critical to finish your CertaWrap installation with tight sealing methods. CertaWrap accessories offer everything needed to get the job done right. Use them to seal window and door openings, cracks, seams and penetrations prior to applying exterior cladding.

CertaFlash™ BA



available in 4" x 75',
6" x 75' and 9" x 75'

CertaFlash™ Flex



available in 6" x 75'
and 9" x 75'

CertaTape™



available in 1-7/8" x 165'

CertaWrap Weather Resistant Barrier provides an added layer of protection against air and moisture damage. It's part of the complete CertaWall Weather Deterrence System™.

- The best defense against mold, mildew and water damage.
- Superior air holdout for better energy efficiency.
- Optimal Permeance Rating of 11.7.
- Outstanding UV performance.
- Excellent surfactant resistance.
- Double-strength tear resistance.
- Easy handling and installation with STUDfinder™.
- Class 1 (A) fire rating
- Lifetime limited warranty.
- Available co-branded with your logo! 

CertaWall Technology

Beauty is more than skin deep. That's especially true when it comes to building or improving a home. Protection from the elements, energy efficiency and long-term performance are just as important as aesthetics. The CertaWall Weather Deterrence System delivers those advantages. As a key component in the system, CertaWrap Weather Resistant Barrier helps assure long-term satisfaction.

The CertaWall Weather Deterrence System

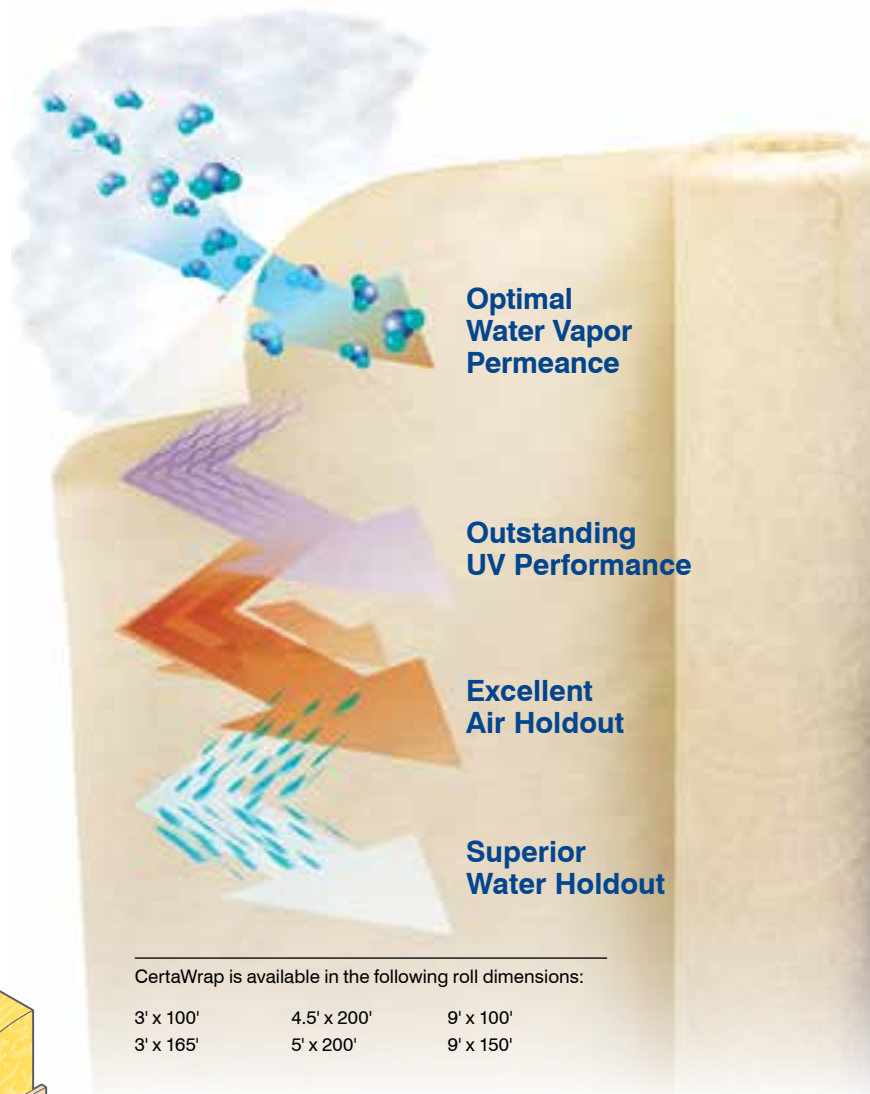
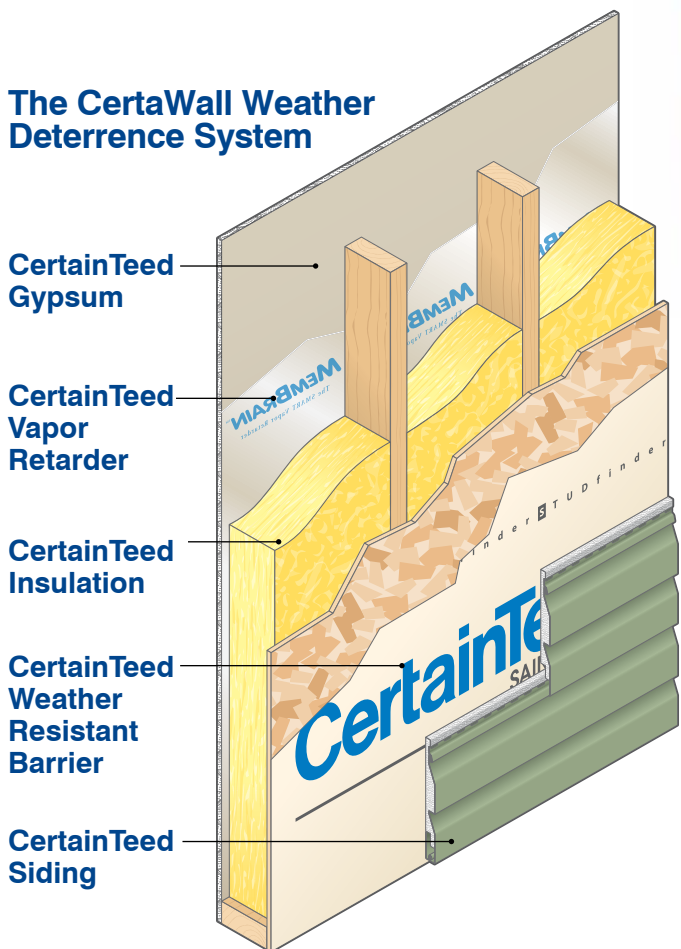

CertaWrap is available in the following roll dimensions:

3' x 100'	4.5' x 200'	9' x 100'
3' x 165'	5' x 200'	9' x 150'

CertaWrap Performance

Superior Breathability, Water Resistance and Vapor Transmission

Mold, mildew and water damage are a home's worst enemies. An effective weather barrier system defends against these problems by resisting moisture penetration and air infiltration while allowing water vapor to dissipate. CertainTeed CertaWrap offers the industry's best combination of all of these properties, helping you defend against moisture and the elements during construction, and preventing moisture buildup – from inside and outside the home – after cladding is applied.

EverNew®

Oxford & Kingston Vinyl Railing Systems



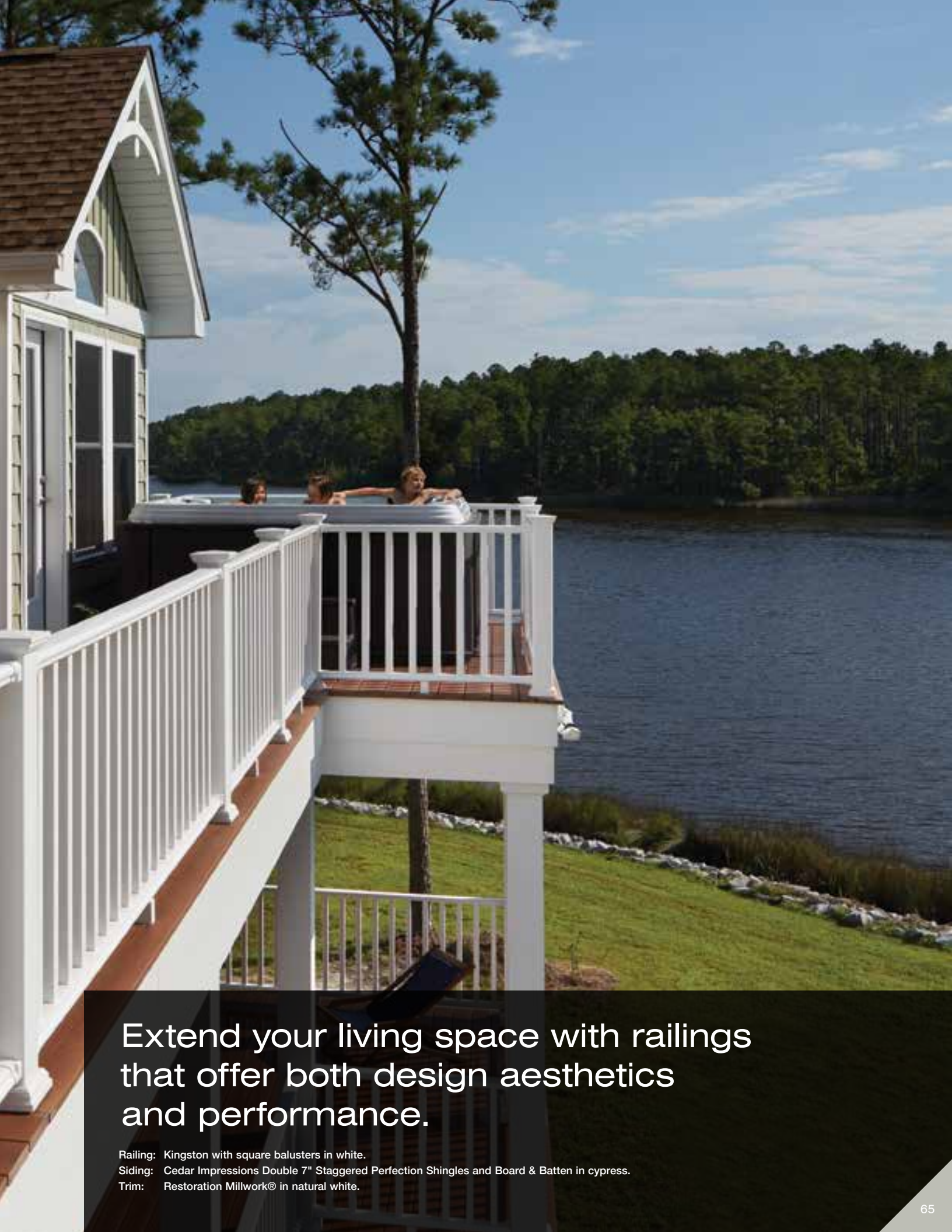

Extend your living space with railings that offer both design aesthetics and performance.

Railing: Kingston with square balusters in white.
Siding: Cedar Impressions Double 7" Staggered Perfection Shingles and Board & Batten in cypress.
Trim: Restoration Millwork® in natural white.

Details Matter

Aluminum reinforced rails, precision-fit components and a wide variety of finishing accessories offers beautiful options and unmatched performance.



Kingston & Oxford BRACKETED Systems

Aluminum rail mount brackets provide a safe and secure metal-to-metal, rail-to-post connection for greater strength and longevity.

Kingston

- Classic bread-loaf rail design for both top and bottom rails.
- Available in two heights and three lengths.
- Suitable for one- and two-family dwellings and townhouses not more than three stories high, as determined by an independent testing agency (CCRR-0211).
- Lifetime limited warranty with 5-year SureStart™ protection.

Oxford

- "T"-rail top and 2x4 bottom rail system.
- Available in two heights and three lengths.
- Independent tested as designated in report CCRR-0187.
- Suitable for residential and commercial applications – including multifamily and over three story installations.
- Lifetime limited warranty with 5-year SureStart™ protection.

Kingston Railing with square balusters in white. Also shown is 6"x 6" Certa-Snap® Post Wrap.



Kingston Railing with traditional balusters in white. Also shown is 8" tapered round structural column.



Oxford Railing with colonial balusters in white. Also shown is 5"x 5" colonial structural post.





Oxford ROUTED System

The ultimate in beauty, safety and performance.

- "T"-rail top and 2x4 bottom rail system.
- Available in two heights and three lengths.
- Independent tested as designated in report CCRR-0187.
- Suitable for residential and commercial applications – including multifamily and over three story installations.
- Lifetime limited warranty with 5-year SureStart™ protection.

Everything you need to make your vinyl railing project a success

Available Colors

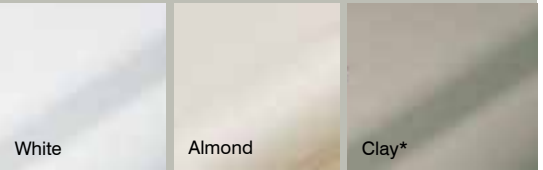

*ColorLast® Dark Color Fade Protection - Our acrylic formulation provides superior protection from the harsh rays of the sun, resulting in richer color that retains its vibrant hue for years to come. ColorLast is offered in Clay.

EverNew Gate Kits

EverNew gates feature a heavy-duty internal aluminum frame for sturdy construction that's built to last and stainless steel fasteners to prevent corrosion.



Decorative Post Caps and Solar Lighting

Featuring a wide variety of metallic, powder coat and solid color finishes. For complete details, refer to CertainTeed's EverNew Decking & Railing Systems brochure (code # 40-70-425).

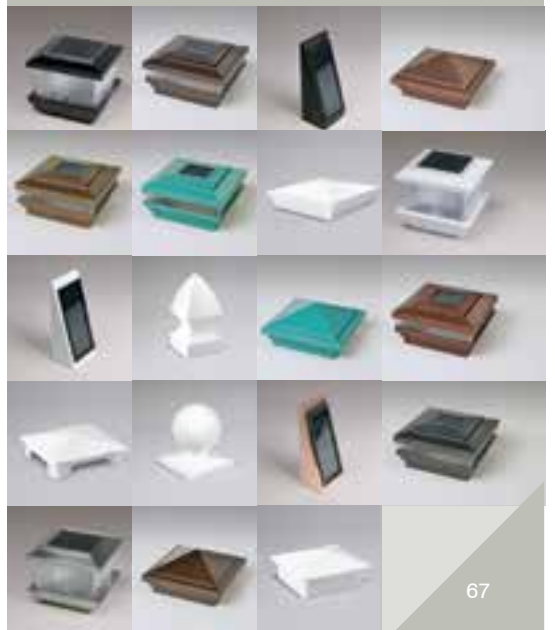

Oxford Railing with square balusters in white.



Oxford Railing in white with clear glass balusters.



EverNew[®]

Panorama[®] Composite Railing System



Panorama in almond with alternating straight, single and double basket steel balusters in antique bronze.

Optional deco cap accessory snaps onto Panorama post cap. Available in antique bronze and oil-rubbed bronze finish to coordinate with decorative steel balusters.

True Architectural Detail

Solid construction, precision-drilled components and a wide variety of baluster options combine for an outstanding PVC capped composite system.

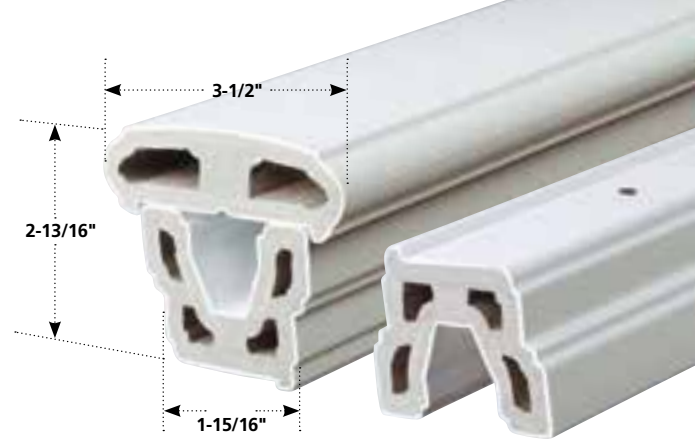

Panorama®

The Panorama capped composite railing system features a classic painted wood railing design with handcrafted authenticity and true architectural details you won't find on any other composite railing. Panorama's concealed, corrosion-resistant stainless steel hardware provides years of worry-free performance.

- Classic painted wood style with true architectural details.
- Available in two heights and two lengths.
- Available in two colors: white and almond.
- Choice of two baluster styles: square composite and decorative steel in antique bronze and oil-rubbed bronze.
- Powder-coated, hot-dipped galvanized steel decorative balusters create a rustic yet customizable system approach for both flat and stair applications.
- Suitable for one- and two-family dwellings/townhouses not more than three stories high, as determined by an independent testing agency (CCRR-0115).
- 25-year limited warranty with 2-year SureStart™ protection.
- Green Approved product by the NGBS.

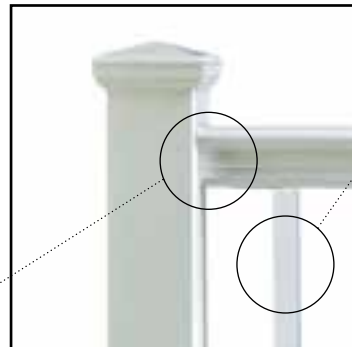
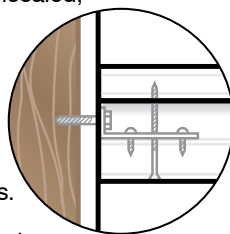

Square Composite Balusters, available in White and Almond.

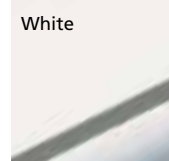

Decorative Steel Balusters in Antique Bronze and Oil-Rubbed Bronze.

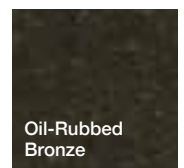
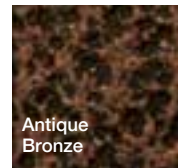

Panorama with square balusters in white.



CertainTeed products are designed to work together and complement each other in color and style to give your home a beautiful finished look.



Polymer Shakes & Shingles



Roofing and Ventilation



Fence



Insulated Siding



PVC Exterior Trim & Beadboard



Decking and Railing



Vinyl Siding



Vinyl Carpentry® Trim



Housewrap



Professional: [facebook.com/CertainTeedFreedomofChoice](https://www.facebook.com/CertainTeedFreedomofChoice)
Consumer: [facebook.com/CertainTeedLivingSpaces](https://www.facebook.com/CertainTeedLivingSpaces)

[Be Certain] Confidence worth building on.™

ASK ABOUT OUR OTHER CERTAINTEED® PRODUCTS AND SYSTEMS:

ROOFING • SIDING • TRIM • DECKING • RAILING • FENCE
 GYPSUM • CEILINGS • INSULATION

www.certainteed.com <http://blog.certainteed.com>

CertainTeed Corporation
 P.O. Box 860
 Valley Forge, PA 19482

Professional: 800-233-8990
Consumer: 800-782-8777

© 3/15 CertainTeed Corporation, Printed in U.S.A.
 Code No. CTS001

